

www.huck-net.co.uk

HUCK 
PLAY EQUIPMENT

2022-2023

CATALOGUE NO. 27



**NEW COLOURED ROPES
AND CONNECTIONS**

**MADE IN
GERMANY**

**ENGLISH
VERSION**



- 11** Rope play equipment for children from the age of 2
- 21** Rope play equipment for children from the age of 3
- 67** Rope play equipment for children from the age of 6
- 107** Parcours
- 119** Climbing nets and bridges
- 135** Swings
- 161** Rope net pyramids
- 183** Trampolines and bouncer
- 199** Playground accessories
- 221** References



Symbol Explanations



EQUIPMENT HEIGHT

This measurement gives the highest level of the equipment in its installed state.



SPACE REQUIREMENT

The maximum dimensions of the equipment – incl. the outer edge of the foundation (if these should exceed the minimum space) – is considered to be the space requirement.



FALL PROTECTION AREA

The exact m² required in fall protection material, which must be laid out, e.g. use of liquid fall protection.



MINIMUM SPACE

Space needed for the safe use of the equipment including the falling area, the open space and the space requirement.



DROP HEIGHT

Measurement which has been calculated for the equipment as free drop height, in order to determine the corresponding fall protection covering.



CONCRETE REQUIRED

The roughly calculated amount of concrete needed for the installation of the play equipment³ – Subject to change depending on situation locally.



NUMBER OF USERS

The determined number of possible allowed users on the play equipment.



DIG-IN GROUND ANCHOR

Equipment installed using ground anchors are ready to be played on within the shortest amount of time, since there is no need to wait for the concrete to set.



ACCESSIBLE

For this equipment we have placed value on utilisation in the inclusion area. Consequently, users with disabilities can enjoy unlimited and accessible play fun.



TÜV TESTED AND CERTIFIED

The TÜV mark confirms our play equipment is tested and certified according to European play equipment norm DIN EN 1176.



IPEMA-TESTED AND CERTIFIED

As member of the International Play Equipment Manufacturers Association (IPEMA) we distribute/offer certified equipment. Check product certification visit www.ipema.org.

Adventure made in Germany
HUCK SPIELGERÄTE

HUCK 
PLAY EQUIPMENT

Dear Readers,

We are pleased that you have our new rope play equipment catalogue no. 27 in your hands.

In our last catalogue we introduced classification according to age groups, which has been very well received by many customers, so we have refined this further. Although, there is a new chapter with additions that span all age groups, e.g. parcours. This is where different elements for varying age groups can be installed within one play area or scheme and accommodate the different age groups together.

This year our catalogue is again full of exciting new equipment, all to be found on the overview on page 4. Brand new this year, fuchsia and

turquoise rope colours as well as three new colours for our plastic connectors, see page 5 for a full list.

In addition to the rope colours, you can customize to order all of our items with colored plastic connectors - without any extra charge!

The back cover page folds out, so you always have an overview of the symbols, rope qualities, colours and customization options.

We hope you enjoy our catalogue: Let yourself be inspired!

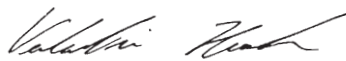

VALENTIN HUCK



STEFAN HUCK



WOLFGANG KEINER

HUCK Seiltechnik GmbH
Management

Huck UK Contacts

HUCK Nets UK Ltd

Gore Cross Business Park,
Corbin Way, Bradpole Bridport
DT6 3 UX, Dorset

sales@hucknetting.co.uk
www.huck-net.co.uk

Phone: +44 1308 425 100
Fax: +44 1308 458 109

Sales Team

Sarah Reynolds +44 1308 425100

Tony Lucas +44 1308 425100
tony.lucas@hucktek.co.uk

Jon Legg-Bagg +44 1308 425100
jon@hucknetting.co.uk

New for 2022

Tarantula

Art. No. 4597-10 / Page 33



Play Cube with slide

Art. No. 4635 / Page 39

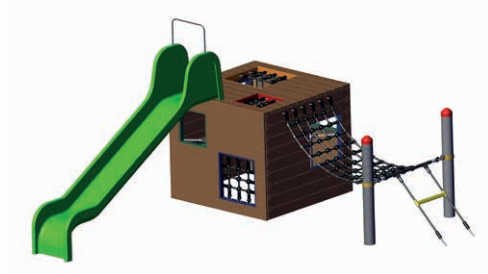

Hexagon Tower

Art. No. 4631-50 / Page 72



Climb and Chill

Art. No. 6200 / Page 74



Bird's Nest Tree "Drago"

Art. No. 4652-70 / Page 88



Swing Frame "Twin"

Art. No. 4577-3-250 / Page 136



XXL-Hammock for Arc Steel Frame

Art. No. 808-2 / Page 156



Deep Space Pyramid

Art. No. 4641-10S / Page 181

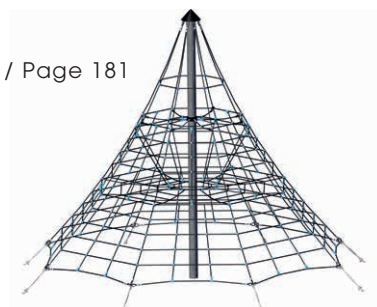



We Bring Colour to Play

With fuchsia & turquoise and new connectors



In 2022 we have added two new variants to our diverse range of colours for the Hercules rope: fuchsia, similar to RAL 4003 and turquoise, similar to RAL 6027. With the two new colors, every playground will be eye catching - fuchsia is a bright pink tone, sending a clear signal. It stands for extravagance and looks inviting. Turquoise is a vibrant yellow-green that radiates security and calmness.

The colours of our plastic connectors (T-piece, ball knot, rope connector) are also completely new this year – in addition to our black and beige colours, they are now also available in yellow, blue and red.

The HUCK Hercules rope consists of six polyester-coated steel strands and has a diameter of 16 mm.

The high quality of the rope is guaranteed. We use a variety of test methods to ascertain the rope breaking forces, test UV resistance, abrasion resistance and dimensional stability. Safety is the top priority for all HUCK products.



Get creative with us
and design your colour
concept free of charge.



The HUCK Hercules-Quality

Adventure made in Germany

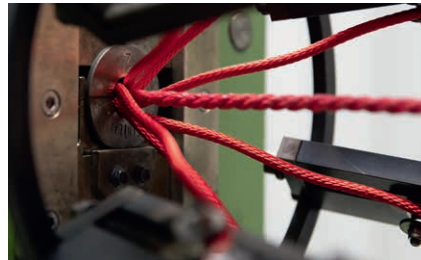
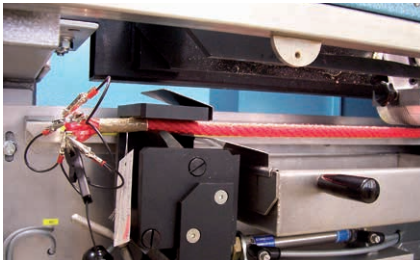

Design and properties

For our Hercules ropes six polyester yarn coated steel strands are twisted into a single rope. A strong connection between the steel and the polyester coating is achieved by the braiding and simultaneous bonding between yarn and steel strands. Our Hercules ropes are made with a nominal diameter of 16mm and 18mm, with the single strands between 5.0 mm and 6.0 mm in diameter.

Compared with other synthetics polyester already has a high resistance to colour, UV and wear and tear. However, to meet demands and loads of play equipment all ropes are also prepared with a surface impregnation during production.

Abrasion testing

Basically, the abrasion topic is one to be observed by all rope-manufacturers, which can never be completely left out. Depending on stress load a Hercules rope never lasts forever. However reinforced abrasion does not mean no safety risks whatsoever – even visible steel cores can simply be classed as purely optical

restriction, there is no danger at the least. Our ropes have been in permanent use in some places for more than 20 years on the playgrounds. We however are constantly taking measures to improve and optimise the quality of our Hercules ropes.

Our own testing machine was set up to simulate abrasion. An abrasive, stainless steel grinder is pushed up and down the rope surface (so-called double stroke) until it reaches the steel core.

The measured double strike is a comparable quality feature for our rope designs.

Colour options

Our Hercules ropes are available in numerous colours:

Ø 16 mm: black, fluorescent orange, hemp coloured, grey, red, fuchsia, blue, yellow, green, turquoise, rust

Ø 18 mm: green, blue, black, red, hemp coloured, yellow

Connecting elements

Our connecting elements (e.g. the tried and tested HUCK knot system, the aluminium ball for 18 mm Ø – Hercules rope or the stainlesssteel pegs for flat nets) are very durable. No sharp corners or edges make for a particularly comfortable playing experience.

Easy onsite replacement

Thanks to the forward-looking design of the elements it is just as easy to replace individual elements on site as it is to replace individual rope pieces.

Coloured matching synthetic parts

For coloured nets we generally use black connecting parts. In the case of natural rope colours (beige) we use colour-matched, beige connecting elements.



Quality assurance with HUCK

Withstand high stresses

Using a pressure-testing machine we test under maximum pressure. Above all our ropes are tested for breaking force. We learn which determined load bolted connections have and which pull-out values work for compressed connections. Also the parts from external suppliers are subjected to constant checks.

UV-resistance

To guarantee long-lasting quality we test components for their UV resistance. This enables us to simulate the behaviour of materials in real outdoor use with UV light. Do they become brittle? Do they lose safety-related properties? Do the colours fade?

Abrasion resistance and form stability

This process is to check material fatigue and wear and tear. Which number of load cycles do we have for connections of springs for example? How does the material react to variable, dynamic loads? The processes are in accordance with specified variable movements or deformations.



TÜV-tested HUCK Quality

DIN standards DIN EN 1176 and DIN EN 1177 govern the safety technical requirements and testing procedures for play equipment which are worked out by the technical commission of the European Committee for Standardization (CEN/TC 136) "Sports, playground and other leisure equipment" and are now valid in 33 CEN member states (European Committee for Standardization). As full member we always state-of-the-art and may consider changes/restoration etc. at any time in our product development. We take compliance with standards and the thus related responsibility very seriously to protect the user from danger during proper and reasonable utilisation of the play equipment.

For many years we have been working very closely in this respect with testing institute "TÜV-SÜD" to comply with current requirements or standards and moreover to improve our products. The certificates we hold confirm the design meets current play equipment standards and

can be provided at any time. At the same time these standards govern the requirements of the subsurface below the play equipment and the monthly, quarterly or yearly controls and maintenance of the play equipment. This essential information is included in every combined assembly and maintenance manuals, helping you to comply with regulations.



IPEMA Certification

HUCK Seiltechnik has been a member of the International Play Equipment Manufacturers Association (IPEMA) since 2016, which is a charitable member organisation.

In the interest of public safety IPEMA offers a product certification programme for public play equipment and surface materials. The programme approves the products of a member in accordance with one or several of the standards specified here.

Certification is by TÜV SOUTH America among others pursuant to the current ASTM 1487 (similar to the European play equipment standard EN 1176).

Subsurface and Drop Height

Ground material	Description	Minimum layer thickness in mm *incl 100 mm wear & tear effect	Max. height of fall mm
Grass / Topsoil	Europe-wide		≤ 1000
Grass / Topsoil	Germany		≤ 1500
Bark mulch	20 - 80 mm particle size	300	≤ 2000
		400	≤ 3000
Woodchip	5-30 mm particle size	300	≤ 2000
		400	≤ 3000
Sand or gravel	0.25-8 mm grain size	300	≤ 2000
		400	≤ 3000
Other materials & layer thickness	Tested according to DIN EN 1177		As tested

Country-specific deviations must be observed.



HUCK Post solutions

Douglas Fir



Bird's Nest Tower, with wood posts (Page 97)

Round-milled, sanded, glazed and with true premium quality and a 10-year guarantee (subject to our maintenance requirements): This core-free and crack-free wood is supplied pre-assembled with hot-dip galvanized post shoes. For cross beams and head beams we give a guarantee of 5 years.

Splitting (heartwood)

Every tree trunk has different degrees of hardness. The inner layers (the heartwood), are softer than the outer wood. That causes stress that leads to cracking, mostly in vertical posts which is not considered critical.

Cracking (core separated)

Our Douglas fir woods are cut through the core. This means each trunk is sawn into 4 parts on the vertical and then round milled to create posts. This significantly reduces the tension between the outer and heart wood and thus the formation of cracks. TÜV tests confirm that if cracks form, the stability of the material is not reduced, no snagging occurs.

Darkening

Due to natural properties the wood can darken over time. It should be noted that during storage and installation, if the wood comes into contact with ferrous metals or moisture, discoloration may occur. This does not affect the durability or quality of the wood.

Robinia



"Hexagon Tower" (Art. No. 4631-50/ Page 72) with robinia posts (available on request)

Robinia posts give our HUCK play equipment a particularly natural look. The only European wood with Resistance class 1, approved for in ground use without need for chemical wood protection.

We give 5-year guarantee on the robinia posts – an additional quality feature because of our guaranteed splint-free posts. The wood is also supplied with 2 security steel straps for added safety.

Steel



Parcours element (Page 111) with steel posts

HUCK steel posts are made from hot-dip galvanized steel, making them extremely robust and resistant to corrosion. With the natural silver effect of the hot-dip galvanizing the colourful rope elements come perfectly into one's own. You can easily jazz up the silver colour onsite yourself using a premium special colour or let us do it using a powder coating in all popular RAL tones.

Your benefits:

- ⊕ durable and easy care
- ⊕ hardy during transport, storage & assembly
- ⊕ scratch-proof surfaces (glossy silver-tone)
- ⊕ silver-tone suits numerous net colours in the range
- ⊕ can be painted with special colour
- ⊕ powder-coating available in all popular RAL tones



We always keep an eye on safety and durability with all of our playground equipment. The different post types, made of steel and wood, enable planners and operators to tailor different playground elements, parcours, to fit requirements and wishes – durability always included.

Most of our playground elements can be combined with any post type. Talk to us about it!



HUCKAluPlus

Our rope playground equipment with aluminium connectors & 18 mm Ø – Hercules rope

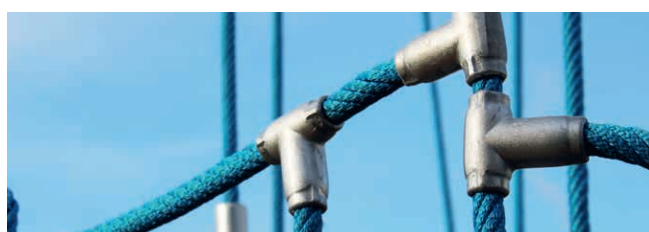
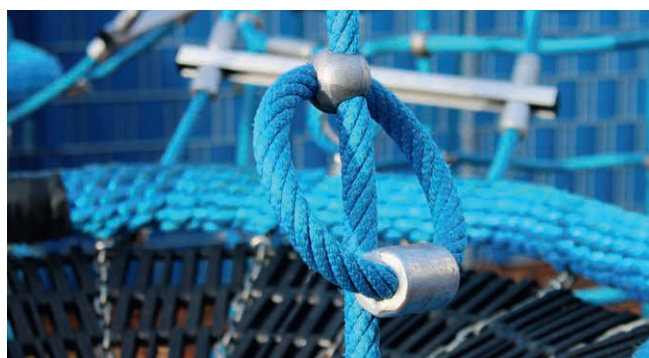

Art. No. 4652-10AP Birds' nest tower "Midi" – AluPlus-Version

Most of our popular rope play equipment is also available on request in the "AluPlus version".

Aluminium-connectors

All relevant rope and net connectors (knot system, T-joints, connectors etc) are made of robust cast aluminium. This material is light yet durable and strong, has virtually no maintenance requirements and is perfectly suitable for permanent use in all-weather conditions. Components in rounded form provide for comfortable playing, running riot and relaxing.

18 mm Ø – Hercules rope

The nets are produced from six-stranded Hercules rope with a diameter of 18 mm – fitted to the aluminium connectors.

With the use of these materials the equipment is an additional upgrade to the popular versions that have been around for many years with synthetic connectors and Hercules ropes in 16 mm diameter.

Speak to us and have us prepare a quote for your rope play equipment in the HUCK AluPlus version.



HAVE FUN!



ROPE PLAY EQUIPMENT

For children from the age of 2

HUCK play and climbing equipment on the following pages is especially suitable for pre-school settings, who look after children from the age of two.

They can run riot on different adventure bridges and courses and let their imagination run free. A multitude of climbing opportunities encourage the children to challenge and improve their abilities.

PRODUCT-HIGHLIGHTS

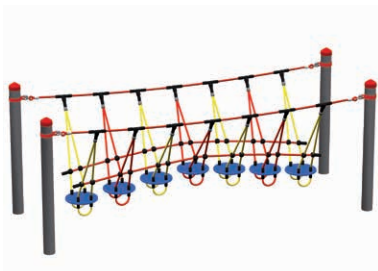

"Wobble Disc" Adventure Bridge
| 12 |



Sparrow's Nest with slide
| 15 |



Mini Bird's Nest Tree
| 17 |













“Wobble Disc” Adventure Bridge

Art. No. 4959-60



For symbol explanation see folding card at the back

-  1.44 m
-  3.10 x 1.10 m
-  15.80 m²
-  5.40 x 3.30 m
-  0.45 m
-  1.75 m³
-  7
- 

Equipment
4 Steel posts (Ø 102 mm),
hot-dip galvanised,
length 2.40 m, with plastic cap

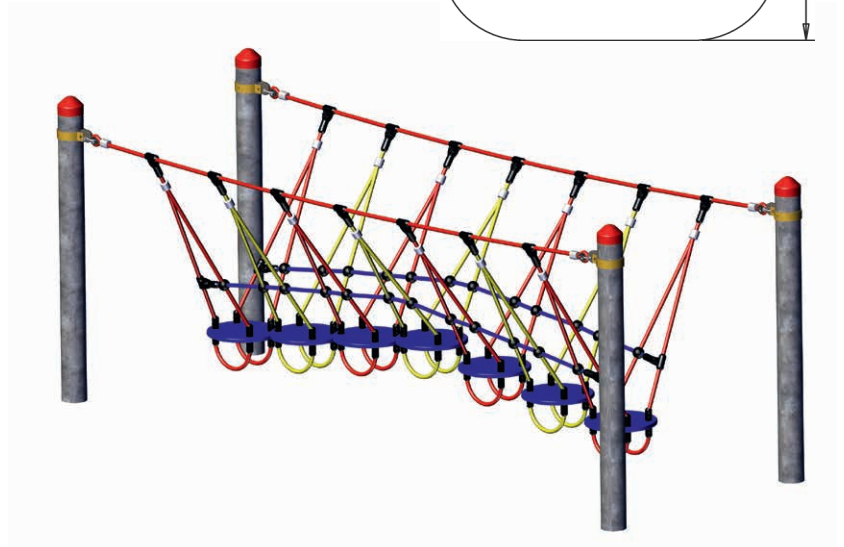
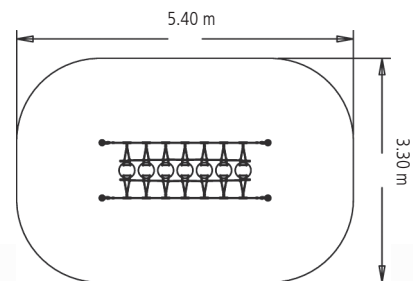









"Haiger" Inclusion Equipment

Art. No. 4591-90



For symbol explanation see folding card at the back

-  1.75 m
-  6.60 x 1.20 m
-  36.20 m²
-  9.10 x 4.20 m
-  0.35 m
-  3.20 m³
-  15
- 
- 

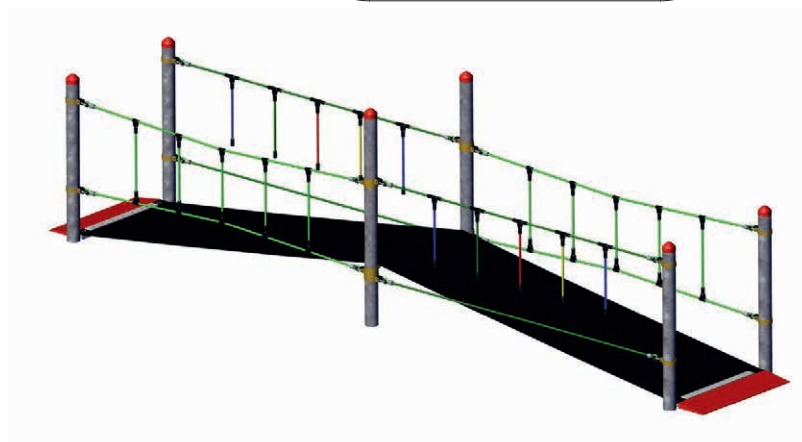
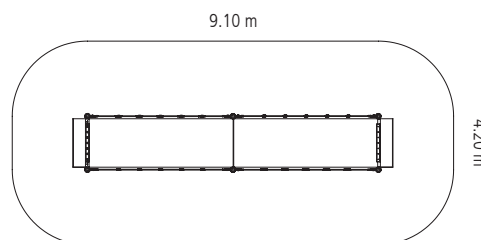

Equipment
 6 Steel posts (Ø 102 mm),
 hot-dip galvanised,
 length: 4 x 2.40 m, 2 x 3.00 m,
 with plastic cap











"Fortuna" Mini Pirate Tower

Art. No. 4687-35



For symbol explanation see folding card at the back

-  2.65 m
-  3.45 x 2.45 m
-  22.10 m²
-  5.90 x 5.10 m
-  1.45 m
-  1.10 m³
-  12
- 

Equipment
1 Steel posts (Ø 102 mm),
length 2.40 m,
4 steel cross posts,
hot-dip galvanised,
length 3.40 m,
with plastic cap

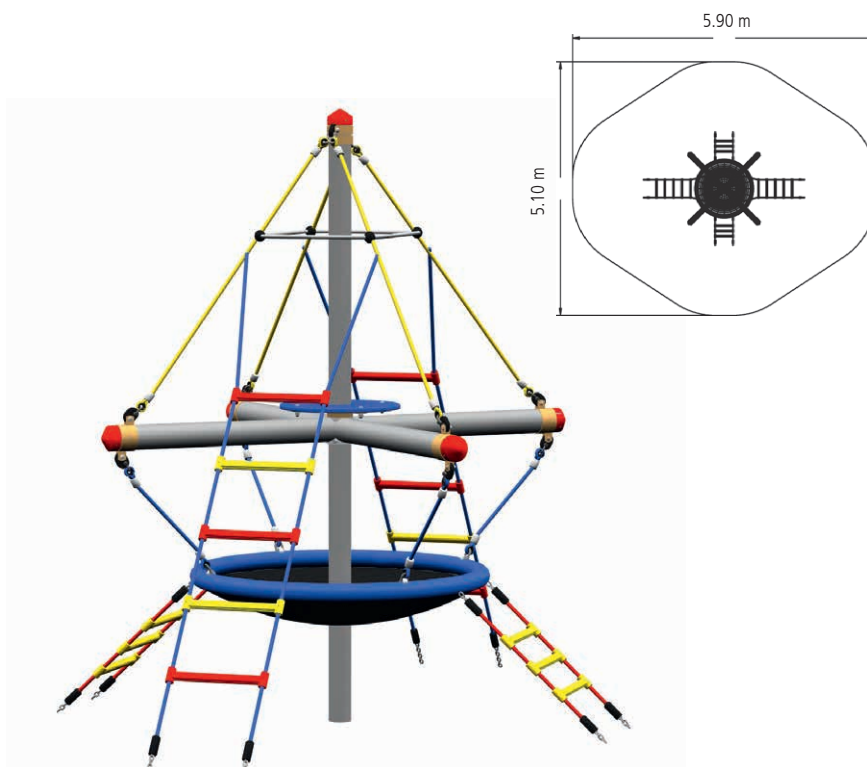

Sparrow's Nest with slide

Art. No. 4668-31, to dig in



For symbol explanation see folding card at the back

-  0.55 m (from top of slide rail: 1.10m)
-  1.65 x 2.90 m
-  18.44 m²
-  5.80 x 4.60 m
-  0.55 m
-  6
- 

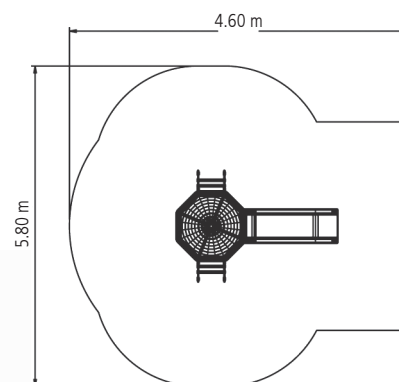







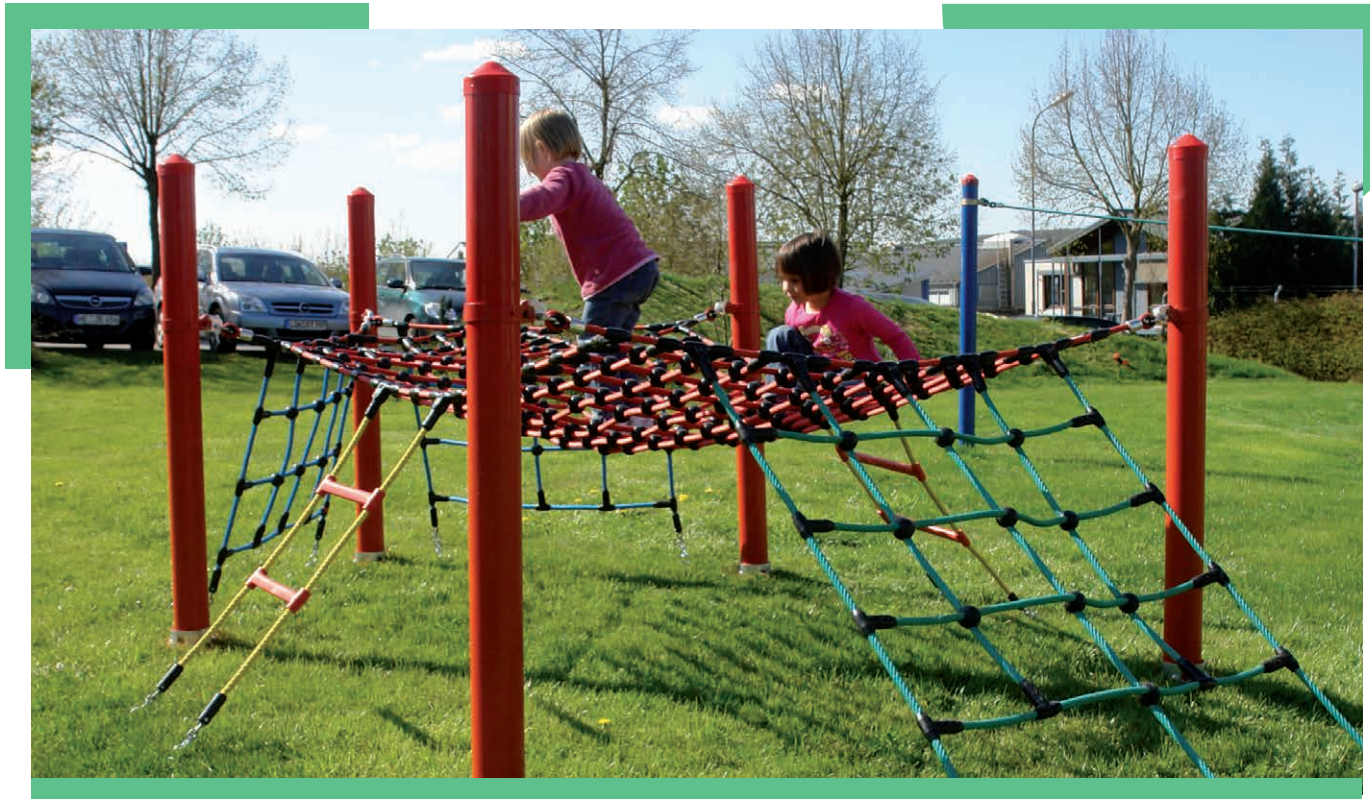

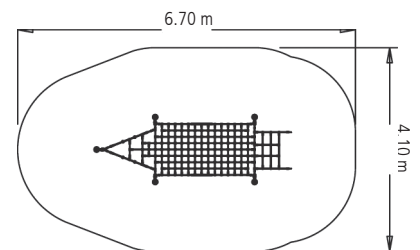

"Junior" Play Ship

Art. No. 4642-10



For symbol explanation see folding card at the back



-  1.44 m
-  4.20 x 1.40 m
-  23.10 m²
-  6.70 x 4.10 m
-  0.80 m
-  1.95 m³
-  12
- 

Equipment
5 Steel posts (Ø 102 mm),
hot-dip galvanised,
length 2.40 m,
with plastic cap

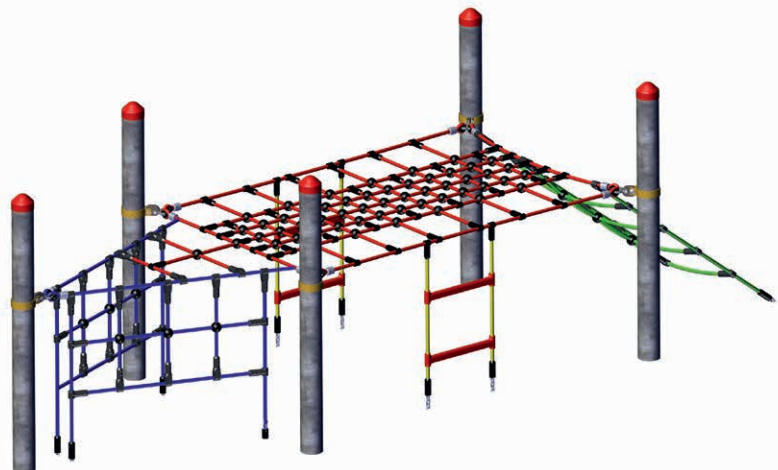









Mini Bird's Nest Tree

Art. No. 4652-30



For symbol explanation see folding card at the back

-  2.85 m
-  3.70 x 3.15 m
-  26.00 m²
-  6.25 x 5.70 m
-  0.80 m
-  0.40 m³
-  18
- 

Equipment

1 Steel posts (Ø 102 mm),
hot-dip galvanised,
length 3.40 m, with plastic cap
4 steel cross posts (Ø 102 mm),
hot-dip galvanised, with plastic cap

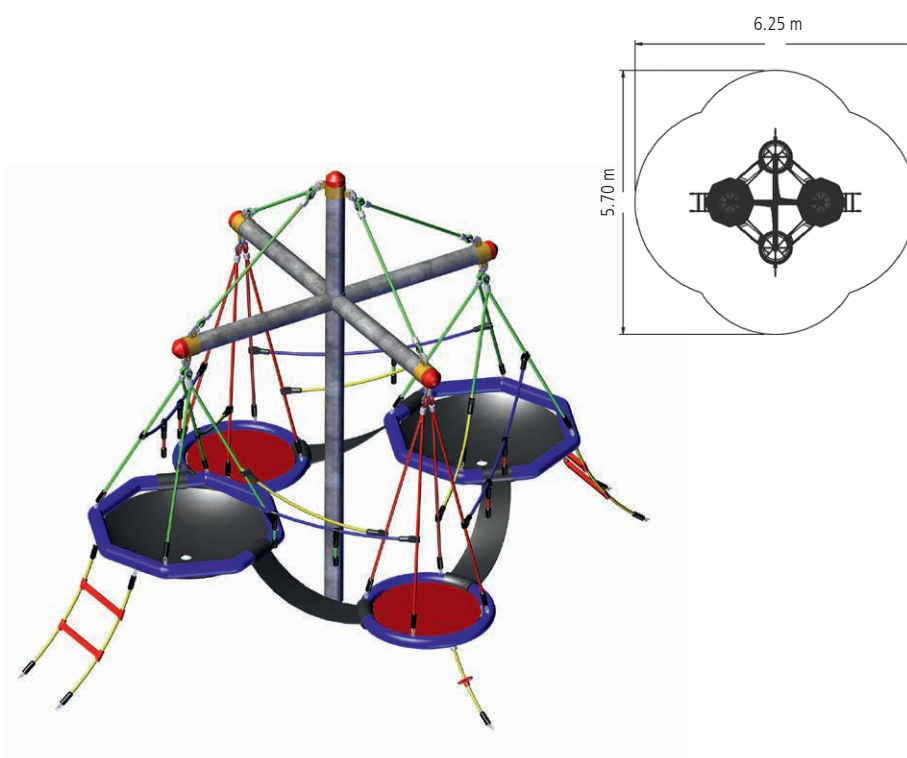











"Fortuna" Bird's Nest Tower

Art. No. 4594-30



For symbol explanation see folding card at the back

-  2.44 m
-  Ø 2.70 m
-  22.10 m²
-  Ø 5.30 m
-  1.00 m
-  0.90 m³
-  12
- 

Equipment
1 Steel posts (Ø 102 mm),
hot-dip galvanised,
length 3.40 m,
with plastic cap

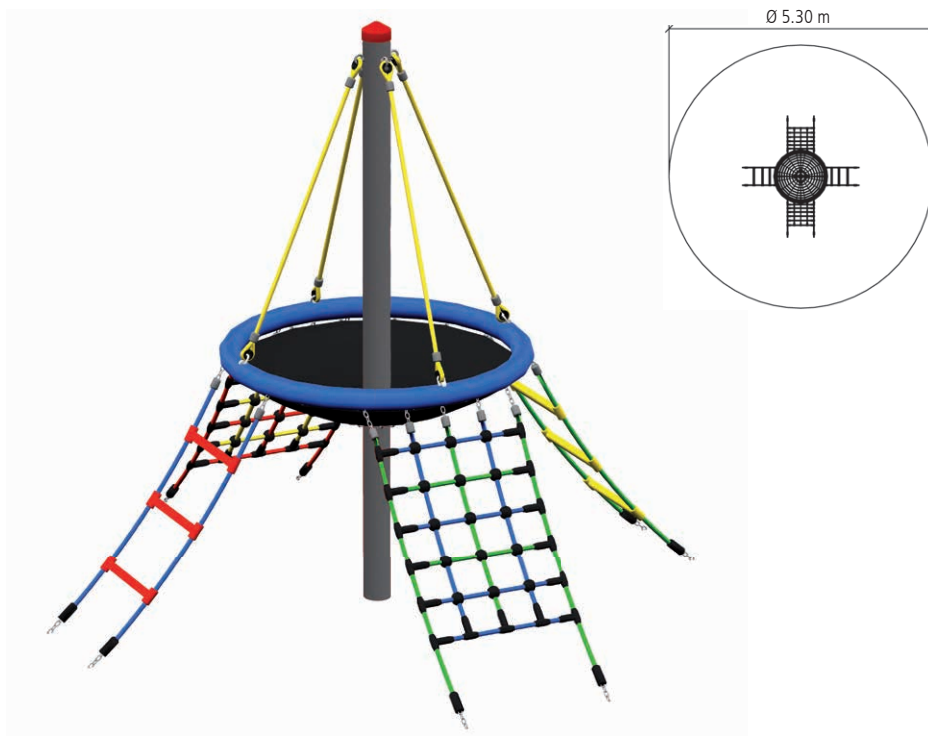







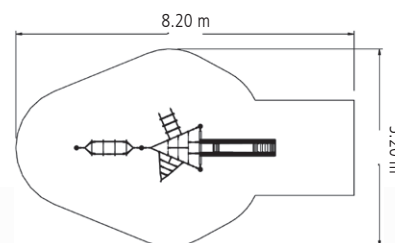

Witch's Slide & Net

Art. No. 4591-20



For symbol explanation see folding card at the back



-  1.80 m
-  5.25 x 2.00 m
-  29.50 m²
-  8.20 x 5.20 m
-  1.00 m
-  0.70 m³
-  7
- 

Equipment
4 Steel posts (Ø 102 mm),
hot-dip galvanised,
length 2.40 m,
with plastic cap

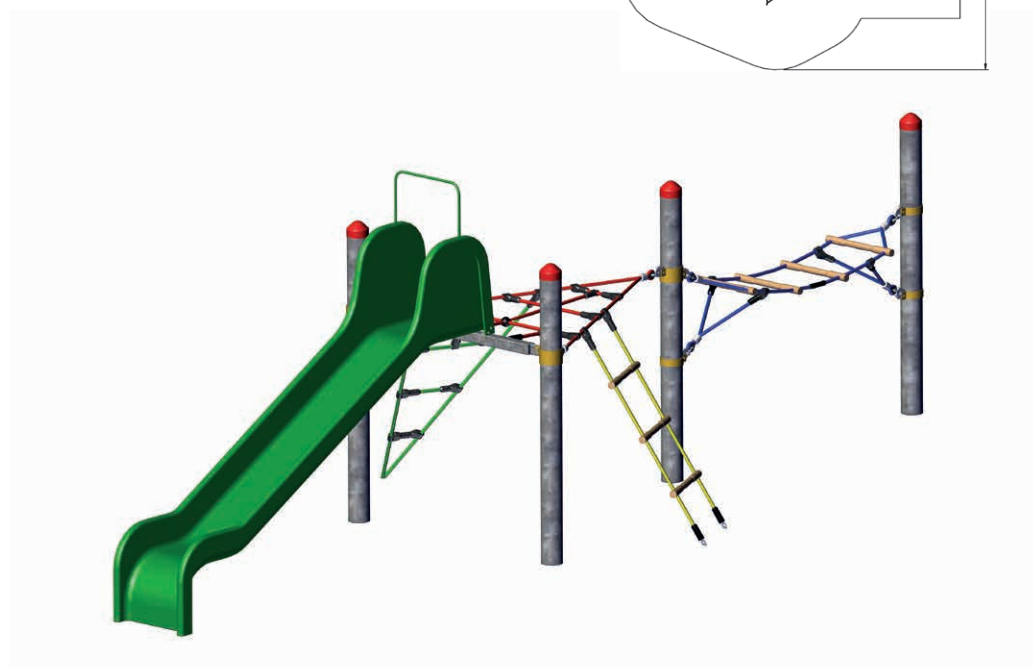



BE HAPPY!



ROPE PLAY EQUIPMENT

For children from the age of 3

In the following pages you will find HUCK's play and climbing equipment, which are especially tailored to the needs of children from the age of 3. Children are challenged and stimulated through play on carousels, group swings and a multitude of obstacle courses, honing in on their motor skills and pushing fun in motion to the very top of the ladder – letting off steam, climbing, swinging, playing is the currency here.

PRODUCT-HIGHLIGHTS



Tarantula
| 33 |



Climbing Bench
| 38 |



Play Cube with slide
| 39 |











Triple Course with slide

Art. No. 4591-66



For symbol explanation see folding card at the back

-  2.65 m
-  7.50 x 5.00 m
-  49.10 m²
-  10.40 x 7.80 m
-  1.00 m
-  1.40 m³
-  25
- 

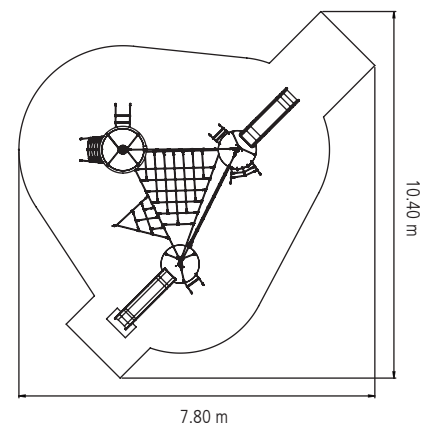

Equipment

- 1 Steel posts (Ø 102 mm), hot-dip galvanised, length 3.40 m
- 1 Steel posts (Ø 102 mm), hot-dip galvanised, length 3.00 m
- 1 Steel posts (Ø 102 mm), hot-dip galvanised, length 2.40 m









All posts with plastic cap

"Fortuna" Play Course

Art. No. 4591-65



For symbol explanation see folding card at the back

-  2.44 m
-  3.75 x 3.40 m
-  32.80 m²
-  6.75 x 6.40 m
-  1.00 m
-  2.25 m³
-  24
- 

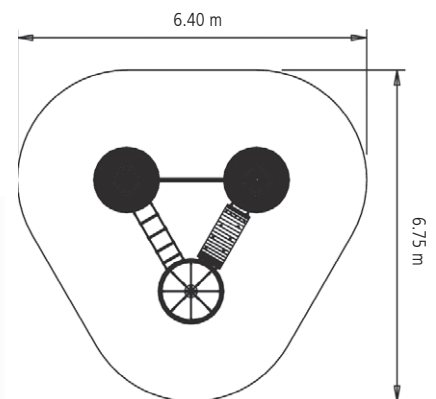

Q Also available in a duo design!

Equipment

- 1 Steel posts (Ø 102 mm), length 3.40 m, hot-dip galvanised
- 1 Steel posts (Ø 102 mm), length 3.00 m, hot-dip galvanised
- 1 Steel posts (Ø 102 mm), length 2.40 m, hot-dip galvanised

All posts with plastic cap

Subject to technical changes











Maxi Hexagonal Climbing Castle

Art. No. 4587-21



For symbol explanation see folding card at the back

-  2.35 m
-  6.10 x 3.80 m
-  46.00 m²
-  8.30 x 7.50 m
-  2.35 m
-  1.50 m³
-  23
- 

Equipment
6-sided construction with
6 Steel posts (Ø 102 mm),
hot-dip galvanised,
length 3.00 m, 6 steel
cross posts each 1.50 m

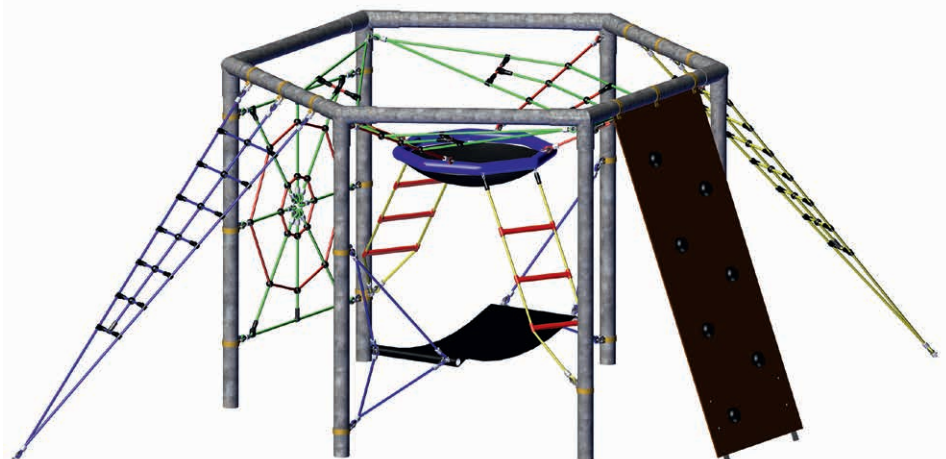
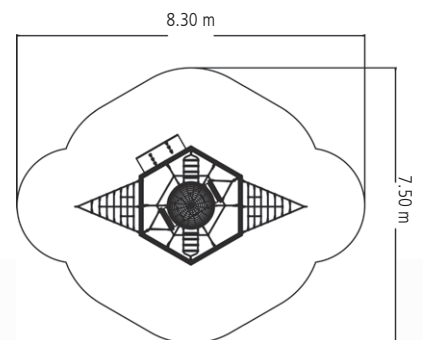









“Wooden Catwalk” Adventure Bridge

Art. No. 4959-20



For symbol explanation see folding card at the back

-  1.44 m
-  3.10 x 1.10 m
-  17.00 m²
-  5.60 x 3.40 m
-  0.60 m
-  1.80 m³
-  9
- 

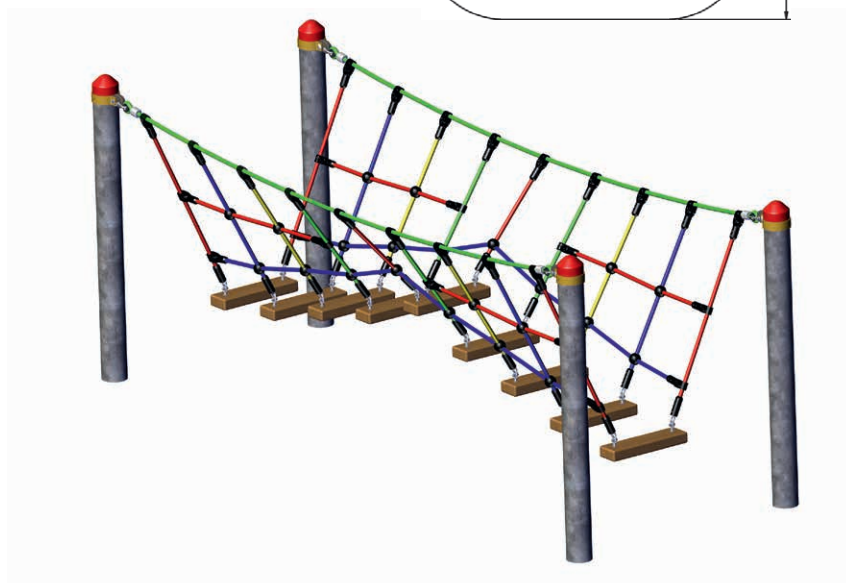
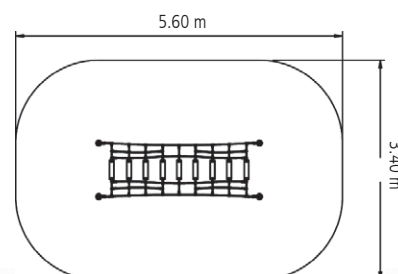

Equipment
 4 Steel posts (Ø 102 mm),
 hot-dip galvanised, length 2.40 m,
 with plastic cap











"Wobble Rung" Adventure Bridge

Art. No. 4959-50



For symbol explanation see folding card at the back

-  1.44 m
-  3.10 x 1.10 m
-  15.70 m²
-  5.20 x 3.40 m
-  0.35 m
-  1.80 m³
-  7
- 

Equipment
4 Steel posts (Ø 102 mm),
hot-dip galvanised, length 2.40 m,
with plastic cap

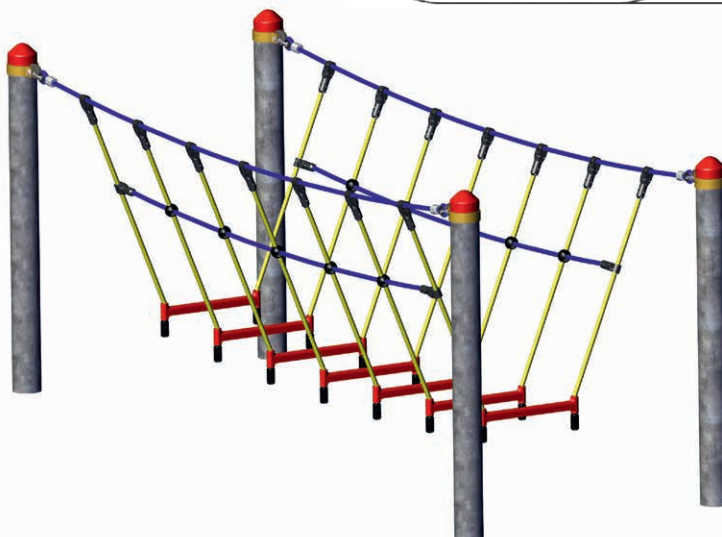
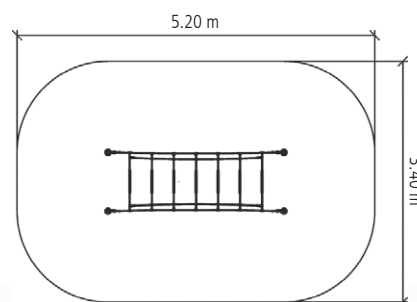









Mini Rope-End Swinger

Art. No. 4585-45



For symbol explanation see folding card at the back

-  1.45 m
-  3.10 x 1.10 m
-  13.6 m²
-  4.90 x 3.20 m
-  0.60 m
-  1.75 m³
-  4
- 

Equipment
4 Steel posts (Ø 102 mm),
hot-dip galvanised, length 2.40 m,
with plastic cap

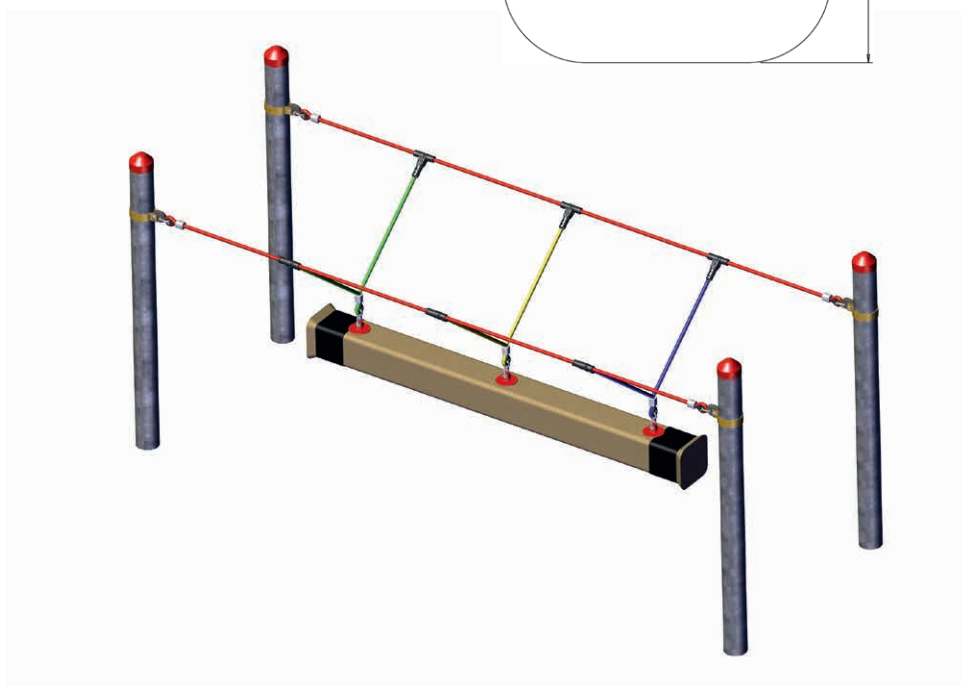
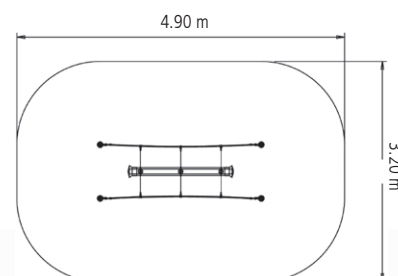











Adventure Honeycomb Nest

Art. No. 4959-70



For symbol explanation see folding card at the back

-  1.44 m
-  4.50 x 1.10 m
-  25.50 m²
-  6.90 x 4.00 m
-  1.20 m
-  2.00 m³
-  9
- 

Equipment
4 Steel posts (Ø 102 mm),
hot-dip galvanised, length 2.40 m,
with plastic cap

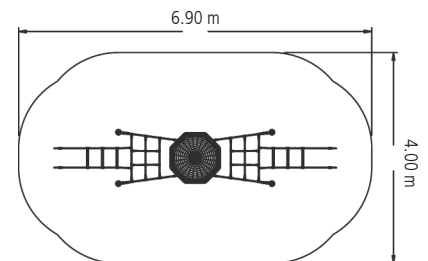









Swinging Honeycomb Nest

Art. No. 4959-71



For symbol explanation see folding card at the back

-  1.44 m
-  3.10 x 1.10 m
-  12.60 m²
-  Ø 4.00 m
-  0.50 m
-  1.80 m³
-  3
- 
- 

Equipment
4 Steel posts (Ø 102 mm),
hot-dip galvanised, length 2.40 m,
with plastic cap

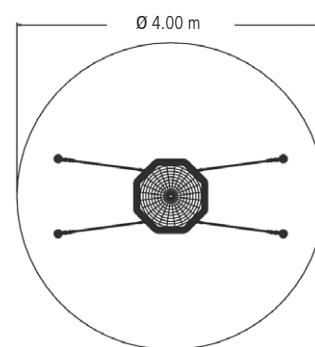











Original HUCK Bird's Nest on springs

Art. No. 4670 for dig-in ground anchor



For symbol explanation see folding card at the back

-  1.00 m
-  Ø 1.25 m
-  8.30 m²
-  Ø 3.75 m
-  1.00 m
-  4
- 
- 
- 

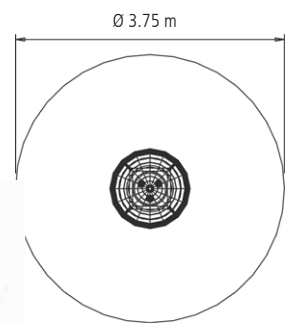





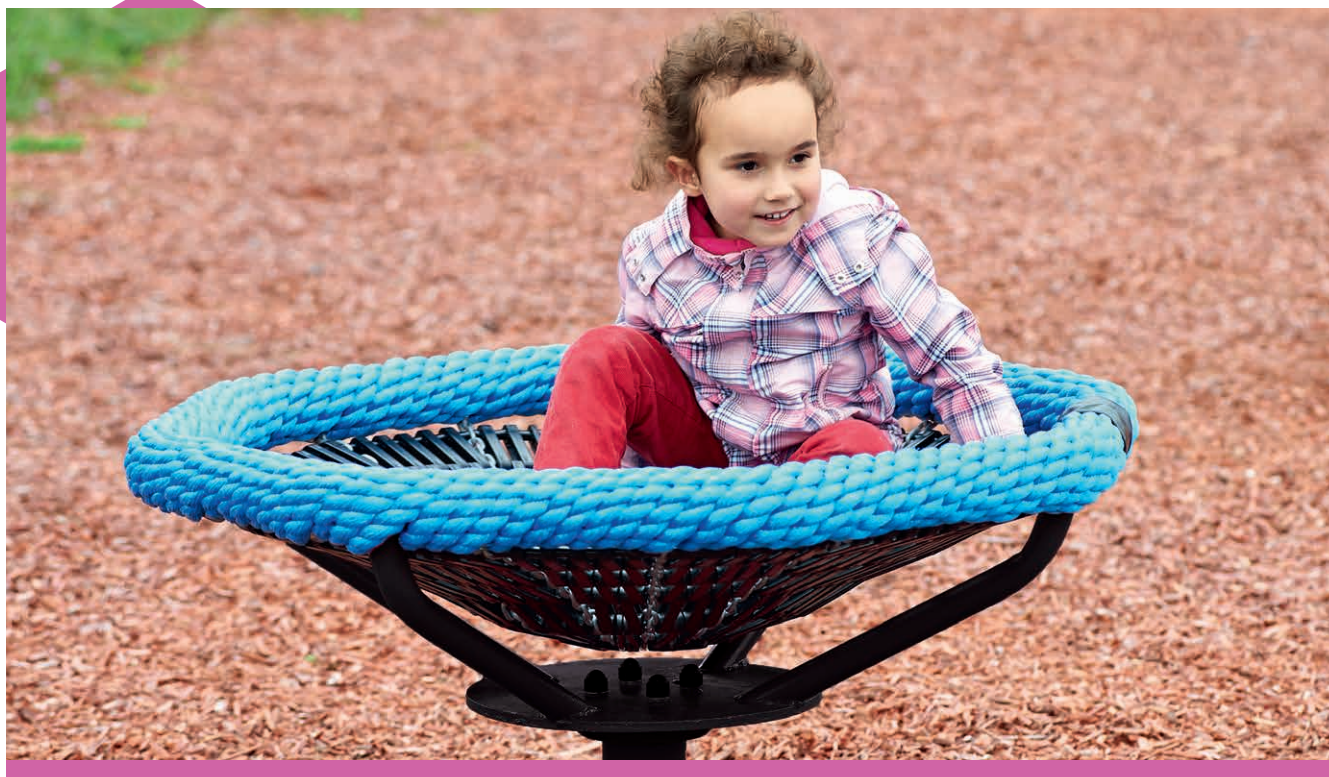

Little Eagle's Nest Carousel

Art. No. 4668-20 for dig-in ground anchor



For symbol explanation see folding card at the back

-  0.45 m
-  Ø 1.00 m
-  19.60 m²
-  Ø 5.00 m
-  0.45 m
-  3
- 

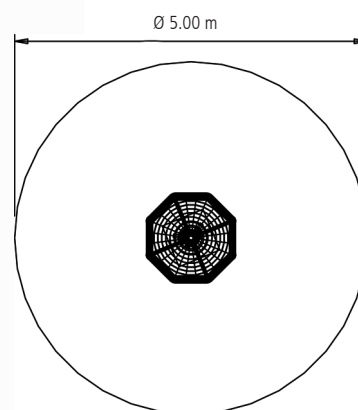



Little Eagle's Nest

Art. No. 4634S with slide (GRP)

Art. No. 4634-1S without slide



Q Slide also available in stainless steel, other colours on request.

For symbol explanation see folding card at the back

Without slide

	1.00 m
	2.75 x 2.10 m
	17.30 m ²
	5.05 x 4.70 m
	1.00 m
	0.70 m ³
	7

With slide

	1.80 m
	3.80 x 2.80 m
	22.30 m ²
	6.40 x 5.00 m
	1.00 m
	0.80 m ³
	8

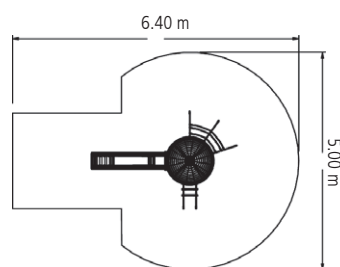
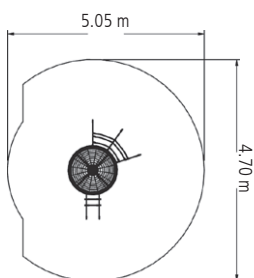









Tarantula

Art. No. 4597-10



For symbol explanation see folding card at the back

-  1.85 m
-  4.10 x 2.90 m
-  28.00 m²
-  6.30 m x 5.30 m
-  1.46 m
-  5.30 m³
-  11
- 

Equipment
6 Steel posts (Ø 102 mm),
hot-dip galvanised, length 3.20 m,
with plastic cap

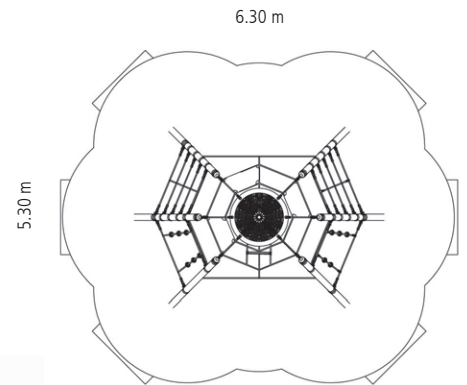

Please note!
The space required for foundations (assembly space) is bigger than the minimum space requirement for the equipment.











Easy-Climb 1

Art. No. 4591-40-1



For symbol explanation see folding card at the back

-  2.44 m
-  2.35 x 2.35 m
-  24.8 m²
-  5.30 x 5.30 m
-  2.05 m
-  1.55 m³
-  10
- 

Equipment
4 Steel posts (Ø 102 mm),
hot-dip galvanised, length 3.40 m,
with plastic cap

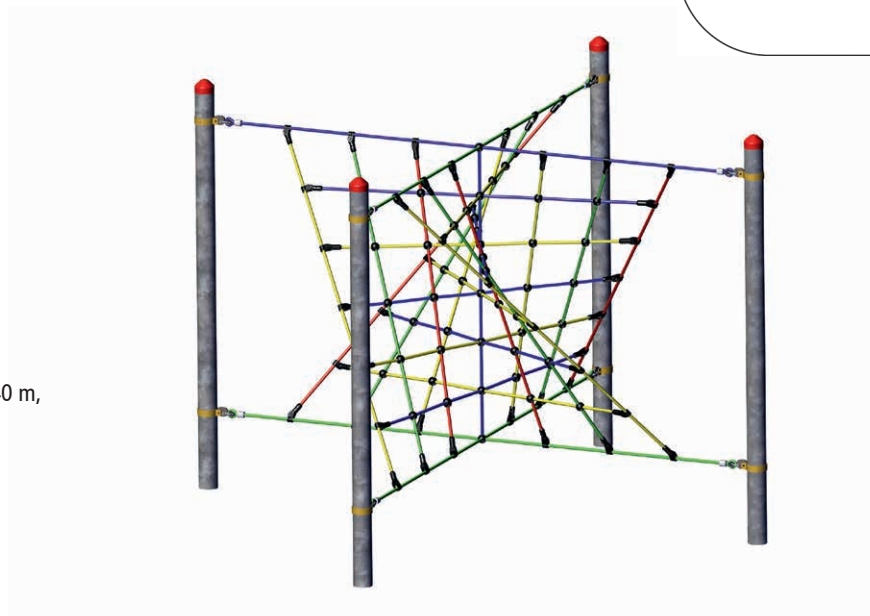
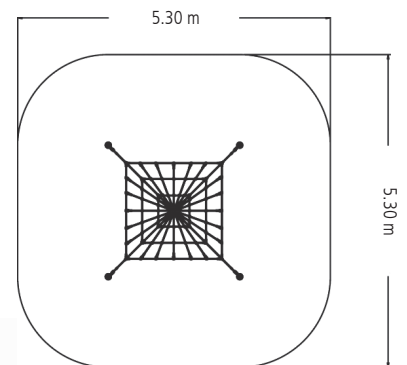









Easy-Climb 4

Art. No. 4591-40-4



For symbol explanation see folding card at the back

-  2.04 m
-  2.35 x 2.20 m
-  18.75 m²
-  4.60 x 4.50 m
-  1.50 m
-  1.25 m³
-  6
- 

Equipment
 2 Steel posts (Ø 102 mm),
 hot-dip galvanised, length 3.00 m,
 with plastic cap

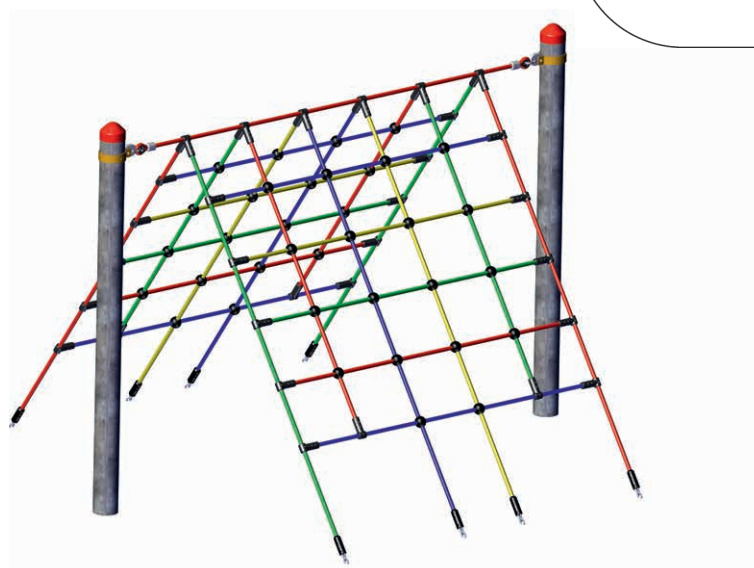
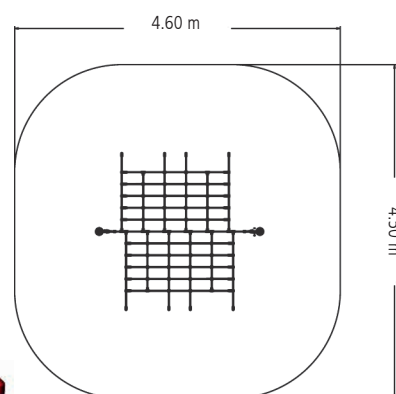











Mini-M Slide

Art. No. 4540-20



For symbol explanation see folding card at the back

-  1.80 m
-  3.00 x 2.20 m
-  19.20 m²
-  5.60 x 4.60 m
-  1.00 m
-  1.25 m³
-  2
- 

Equipment
2 Steel posts (Ø 102 mm),
hot-dip galvanised, length 2.40 m,
with plastic cap

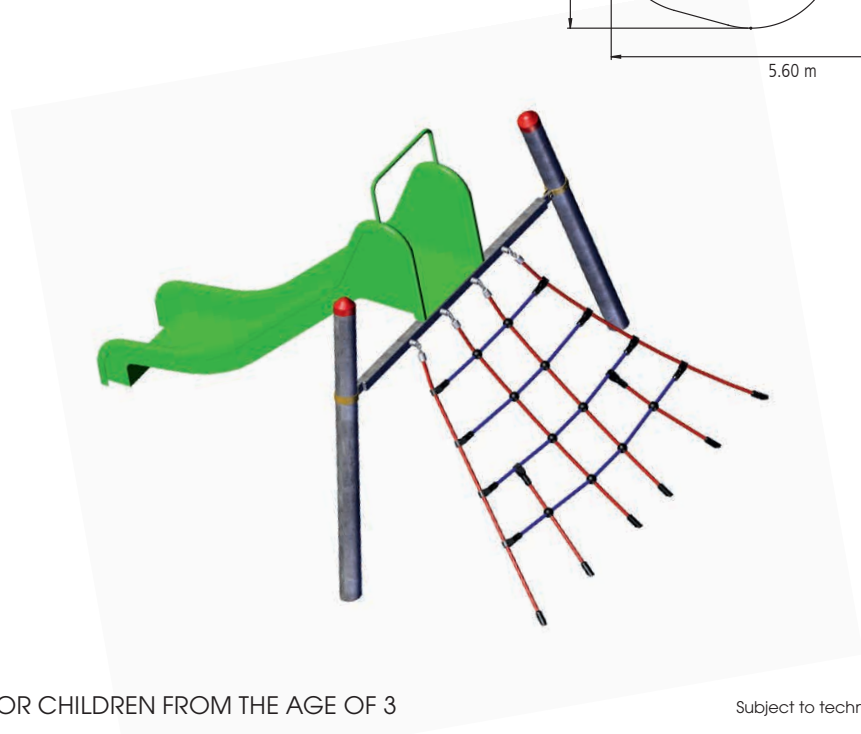
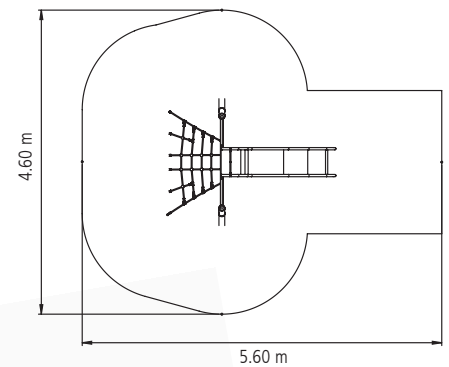

Climbing Equipment "Colour mix"

Art. No. 4960-500, Powder-coated steel posts (Colour tone as required)

Art. No. 4960-500F, Hot dip galvanized steel



For symbol explanation see folding card at the back

- 3.55 m
- 3.45 x 3.15 m
- 28.00 m²
- 6.20 x 6.10 m
- 1.00 m
- 2.10 m³
- 11
-

Post Lengths
 Art. No. 4960-500 and Art. No. 4960-500F
 2 posts, each 4.50 m
 2 posts, each 4.00 m
 2 posts, each 2.50 m

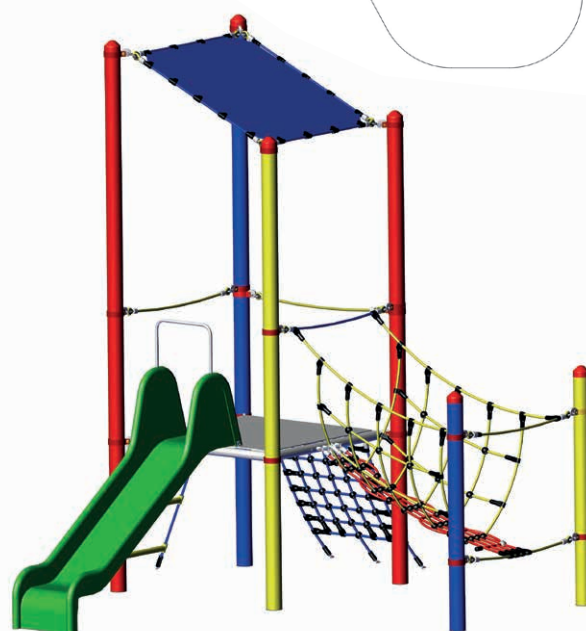
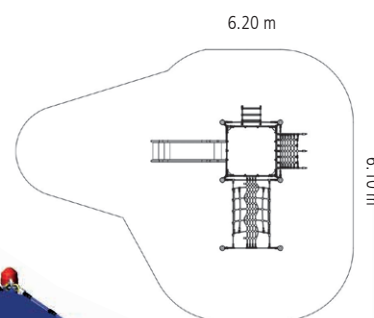

Art. No. 4960-500
 6 Steel posts (Ø 102 mm), hot-dip galvanized and powder coated (colour as requested), with plastic cap

Art. No. 4960-500F
 6 Steel posts (Ø 102 mm), hot-dip galvanized, with plastic cap









Climbing Bench

Art. No. 4800



For symbol explanation see folding card at the back

-  1.80 m
-  4.05 x 1.95 m
-  26.20 m²
-  7.00 x 4.80 m
-  1.00 m
-  21
- 

Equipment
Steel frame, hot-dip galvanised,
with plastic cap,
Seating made of plastic planks

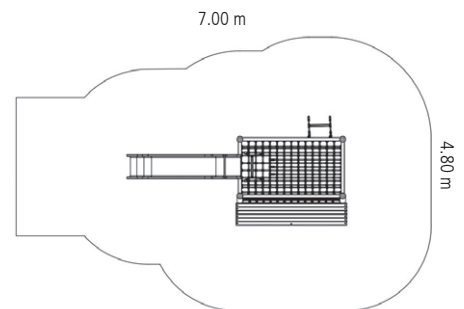









Play Cube with slide

Art. No. 4635



For symbol explanation see folding card at the back

-  1.80 m
-  3.00 x 3.25 m
-  26.30 m²
-  6.20 x 5.70 m
-  1.00 m
-  1.00 m³
-  13
- 

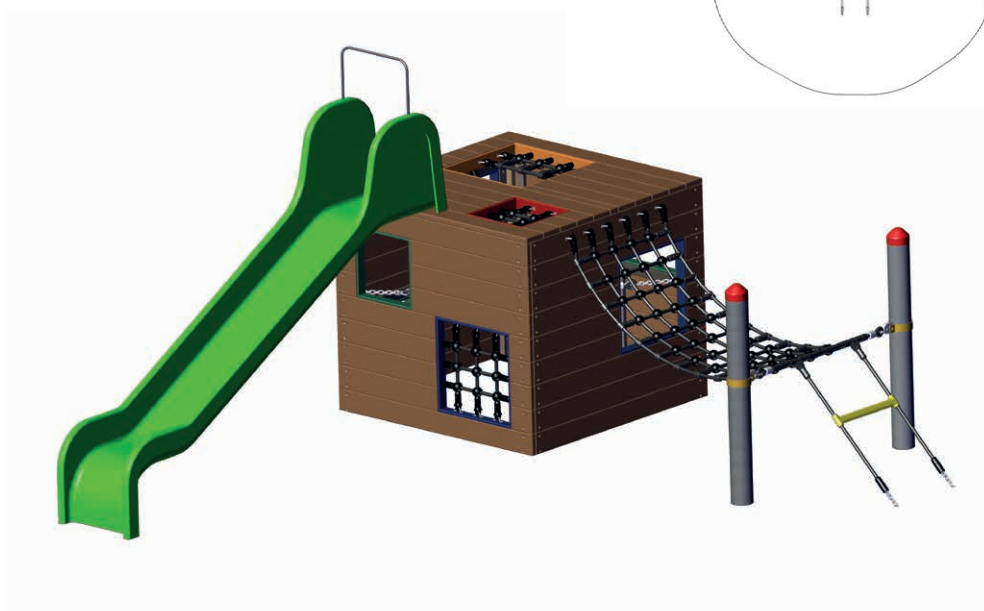
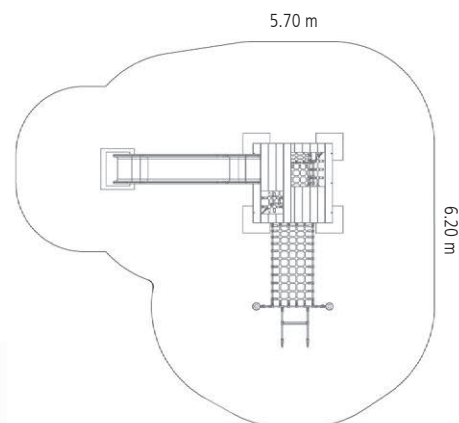

Equipment
 Cube made from robinia wood,
 2 Steel posts, hot-dip galvanised,
 length 2.40 m, with plastic cap



Lantern Climbing Nest

Art. No. 4530-20



Lantern Swing Nest

Art. No. 4530-50



For symbol explanation see folding card at the back

	2.50 m	Equipment 1 Steel posts (Ø 160 mm), hot-dip galvanised, length 3.50 m
	2.10 x 1.00 m	
	14.50 m ³	
	Ø 4.30 m	
	1.50 m	
	0.70 m ³	
	6	

For symbol explanation see folding card at the back

	2.50 m	Equipment 1 Steel posts (Ø 160 mm), hot-dip galvanised, length 3.50 m
	2.00 x 0.76 m	
	14.50 m ³	
	Ø 4.30 m	
	0.55 m	
	0.70 m ³	
	2	



Liana Swing, spinning

Art. No. 20.01.090S



For symbol explanation see folding card at the back

-  3.40 m
-  Ø 3.50 m
-  50.00 m² / 95.00 m²
-  Ø 8.00 m
recommended Ø 11.00 m
-  1.00 m
-  1.20 m³
-  4
- 











Meeting-Point

Art. No. 20.02.134



For symbol explanation see folding card at the back

-  0.60 m
-  4.30 x 4.30 m
-  48.50 m²
-  7.10 x 7.10 m
-  0.60 m
-  2.50 m³
-  34
- 

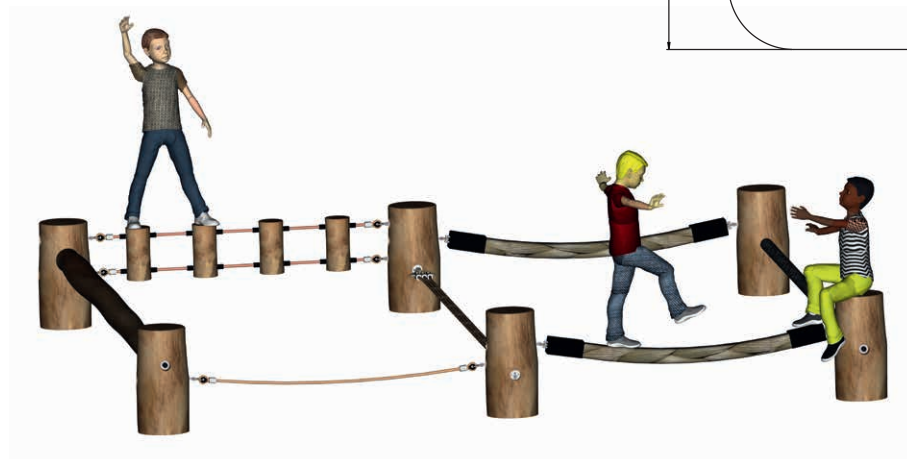
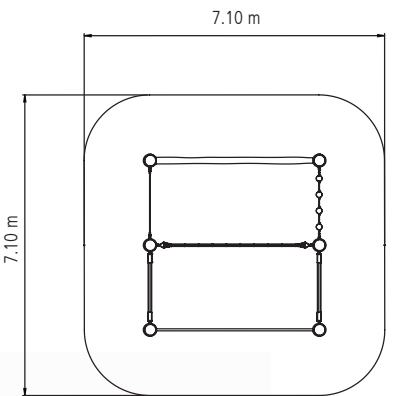

Midi-Climbing Whirl, spinning

Art. No. 20.01.135



Mini Climbing Pyramid, spinning



Art. No. 20.01.070S



For symbol explanation see folding card at the back

	3.00 m
	Ø 2.00 m
	38.50 m ² / 78.55 m ²
	Ø 7.00 m / Ø 10.00 m
	1.70 m
	1.00 m ³
	8
	

For symbol explanation see folding card at the back

	3.00 m
	Ø 3.50 m
	50.20 m ²
	Ø 8.00 m - Ø 10.00 m
	2.00 m
	1.20 m ³
	15
	



Diablo, spinning

Art. No. 4592-20



For symbol explanation see folding card at the back

-  3.00 m
-  Ø 1.85 m
-  24.20 m²
-  Ø 5.60 m
recommended Ø 7.00 m
-  2.00 m
-  1.15 m³
-  15
- 

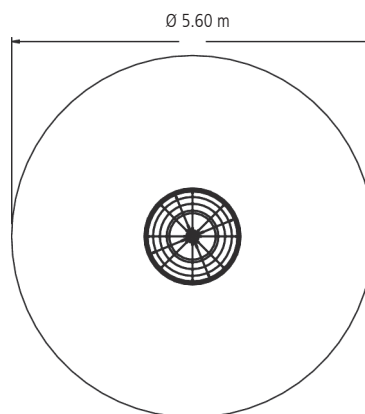









The Look Out

Art. No. 4592-10



For symbol explanation see folding card at the back

-  4.15 m
-  Ø 1.50 m
-  21.70 m²
-  Ø 5.30 m
-  2.10 m
-  2.50 m³
-  15
- 

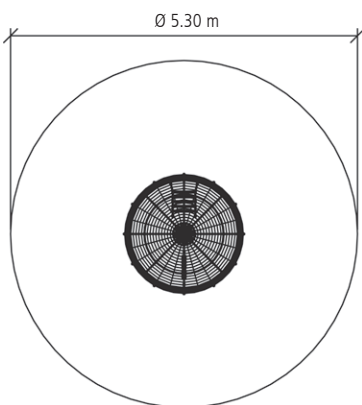
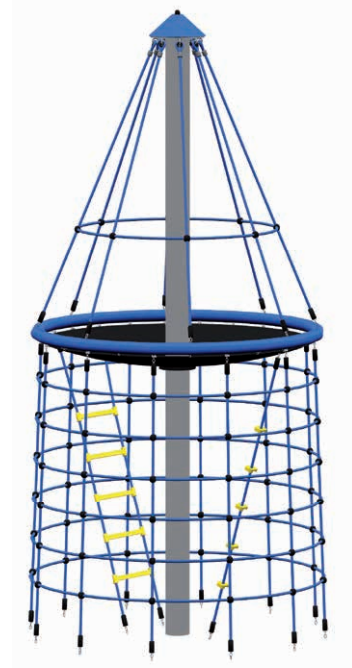



Bird's Nest Carousel, spinning

Art. No. 20.01.080S



Mini Bird's Nest Carousel, spinning

Art. No. 20.06.130 for dig-in ground anchor



For symbol explanation see
folding card at the back

	3.00 m
	Ø 1.90 m
	28.25 m ²
	Ø 6.00 m recommended Ø 9.00 m
	0.80 m
	1.20 m ³
	8

For symbol explanation see
folding card at the back

	2.20 m
	Ø 1.40 m
	23.75 m ²
	Ø 5.50 m recommended Ø 8.00 m
	0.80 m
	6



Spiral Carousel, spinning

Art. No. 20.01.120S

Nest Carousel, spinning

Art. No. 4594-41



For symbol explanation see folding card at the back

	3.00 m
	Ø 1.90 m
	28.25 m ²
	Ø 7.00 m recommended Ø 10.00 m
	2.00 m
	1.20 m ³
	13

For symbol explanation see folding card at the back

	1.80 m
	Ø 1.20 m
	14.40 m ²
	Ø 4.30 m recommended Ø 6.00 m
	0.45 m
	0.40 m ³
	6

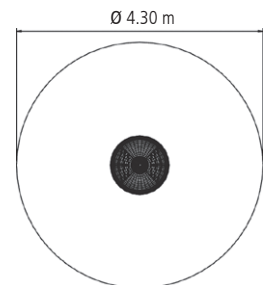











Net Seesaw with wood

Art. No. 4587



For symbol explanation see folding card at the back

-  1.30 m
-  4.35 x 0.90 m
-  26.50 m²
-  7.35 x 3.90 m
-  1.25 m
-  0.80 m³
-  6
- 

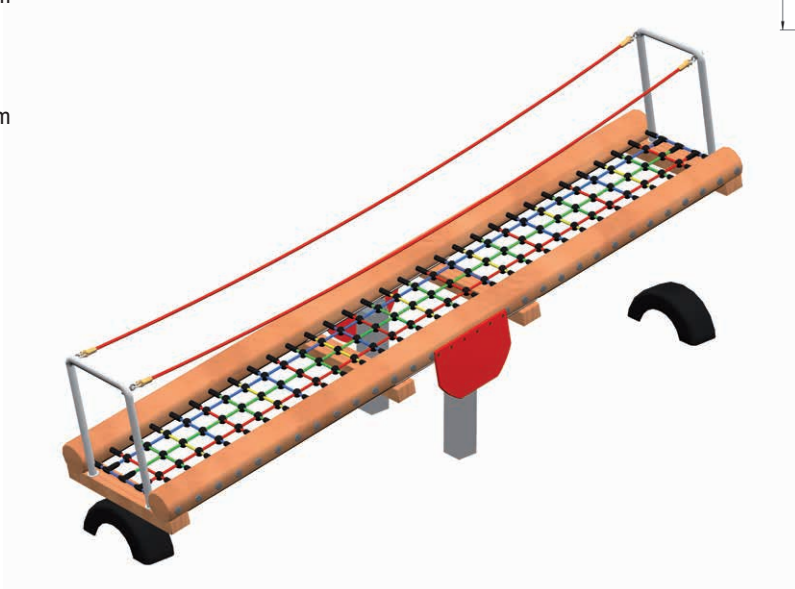
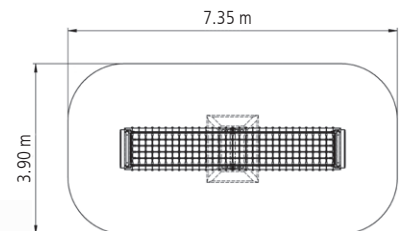









Net Seesaw with steel

Art. No. 4587S



For symbol explanation see folding card at the back

-  1.40 m
-  4.35 x 0.80 m
-  26.00 m²
-  7.35 x 3.80 m
-  1.20 m
-  0.80 m³
-  6
- 

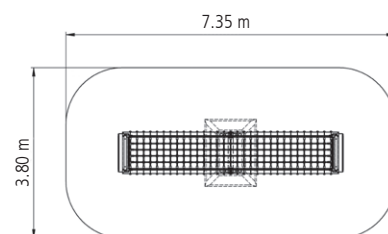



Mushroom Carousel with steel mast, spinning

Art. No. 20.05.110S



For symbol explanation see
folding card at the back

 1.20 m

 Ø 2.00 m

 28.25 m²

 Ø 6.00 m

 0.90 m

 0.40 m³

 14











Mini Pirate Tower

Art. No. 4687-30



For symbol explanation see folding card at the back

-  3.85 m
-  4.25 x 4.00 m
-  35.80 m²
-  6.80 x 6.70 m
-  1.45 m
-  1.20 m³
-  15
- 

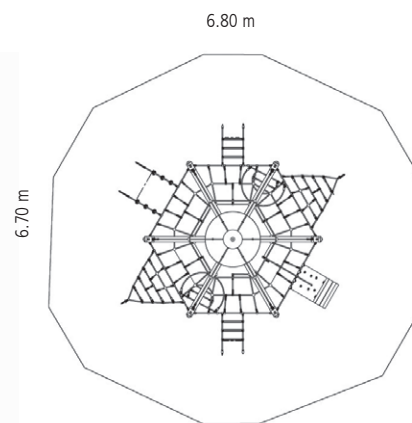

- Q „Fortuna“ Mini Pirate Tower (Page 14)
- Q „Störtebeker“ Pirate Tower (Page 81)







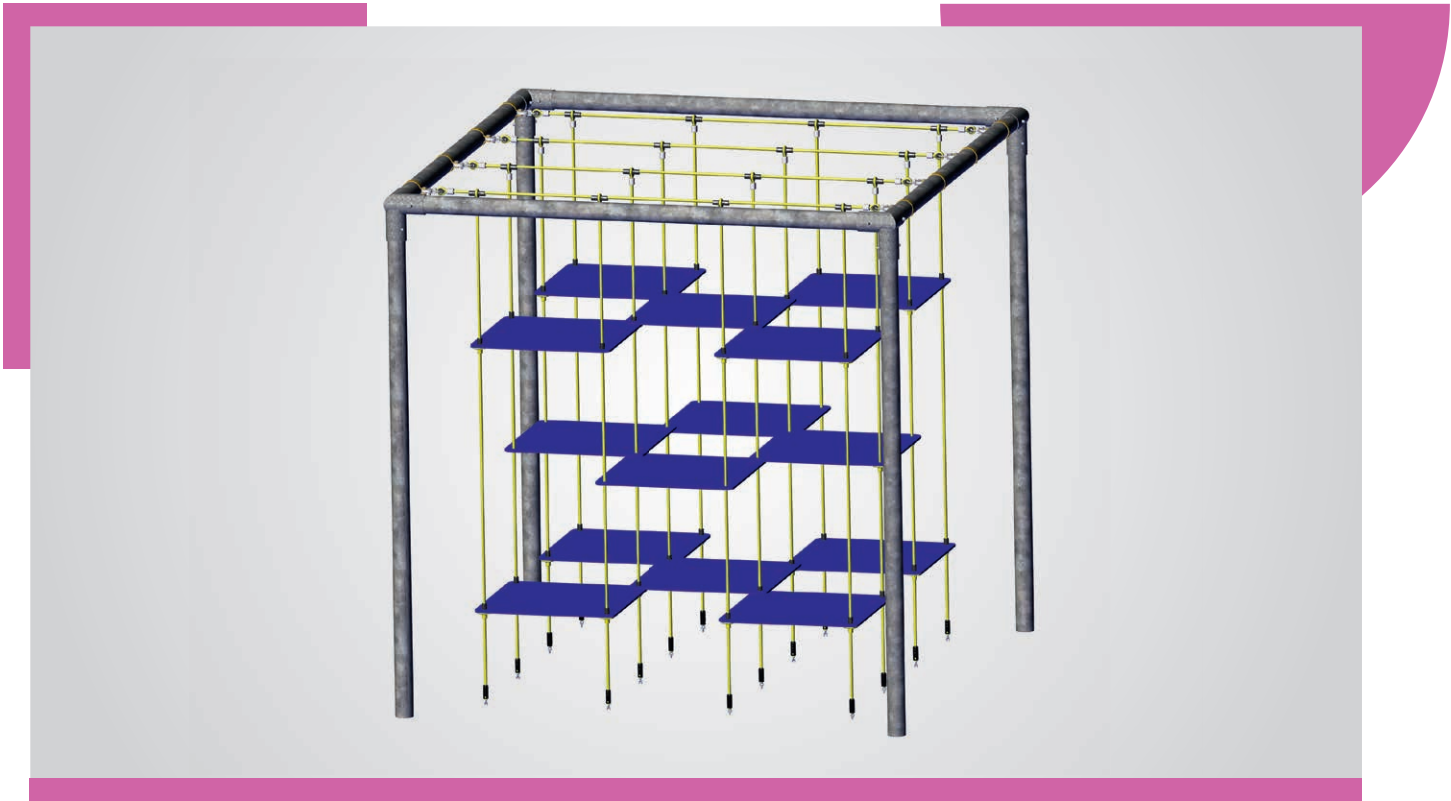



Floating Mats

Art. No. 4538-10



For symbol explanation see folding card at the back

-  2.95 m
-  2.95 x 2.95 m
-  30.00 m²
-  5.71 x 5.71 m
-  1.90 m
-  5.30 m³
-  20
- 

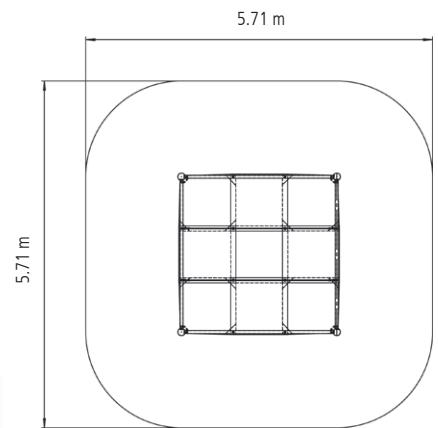

🔍 Rubber mats also available in other colours. Ask us!











Spider Web

Art. No. 4597S Steel posts

Art. No. 4597PS Douglas fir posts, with post shoes



For symbol explanation see folding card at the back

-  1.95 m
-  Ø 3.95 m
-  36.60 m²
-  6.00 x 5.65 m
-  1.50 m
-  2.00 m³
-  16
- 

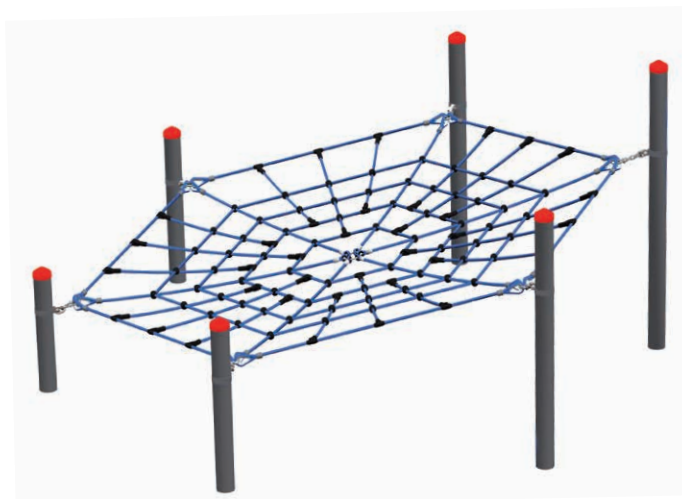
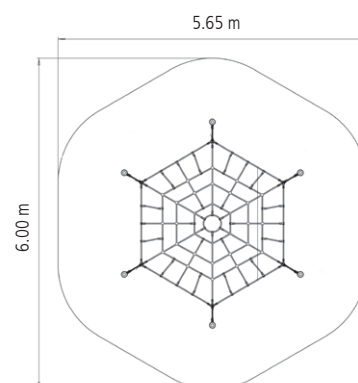

Equipment
6 Steel posts (Ø 102 mm),
hot-dip galvanised,
length 2.00 - 3.00 m,
with plastic cap





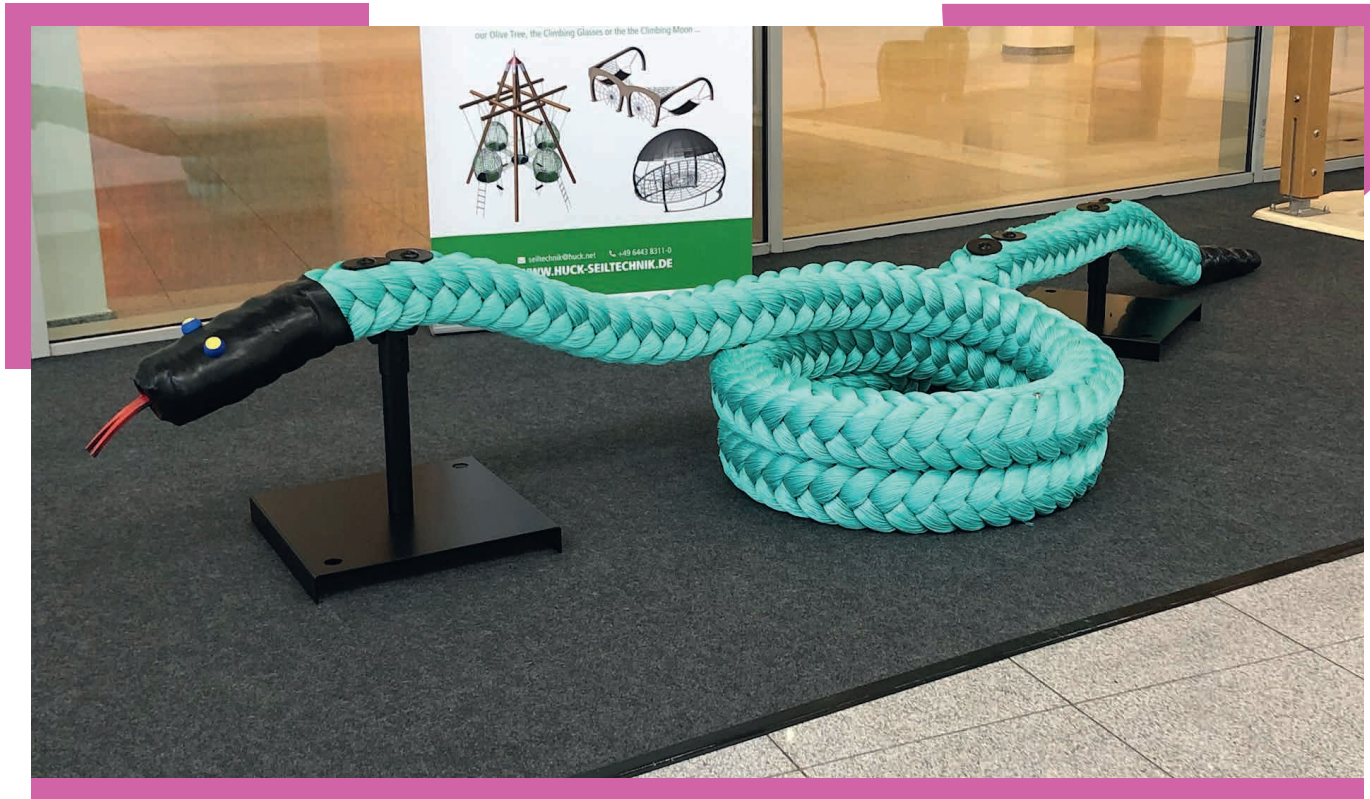

Anaconda Maxi

Art. No. 4591-81AM



Our rope-lengths made from square-braided PP rope. 160 mm Ø (green, blue, black or beige) – in 4 different sizes – are the ideal play comrade for children who would like to practice their balancing. In the same way they are open to crawling through them, laying on them and sitting on them. You can install the equipment in 3 different layouts – depending on the available space requirement (Example Art. 4591-81AM Anaconda Maxi). The frames can be set up individually. Please keep a minimum surrounding distance of 1.50 m.

For symbol explanation see folding card at the back

-  0.60 m
-  8.50 x 8.50 m
-  0.60 m
-  27
- 



Slowworm Midi

Art. No. 4591-81BM

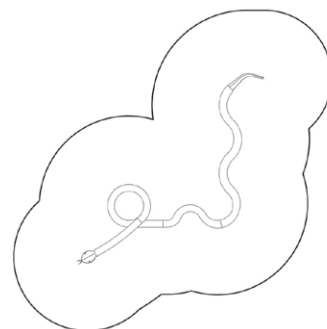
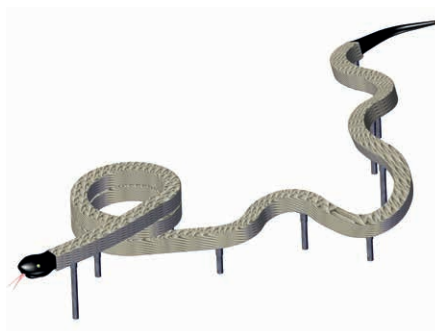
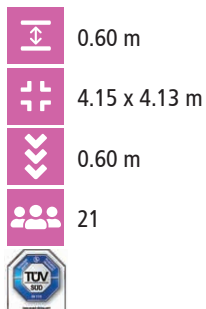

Earthworm Mini

Art. No. 4591-81RM

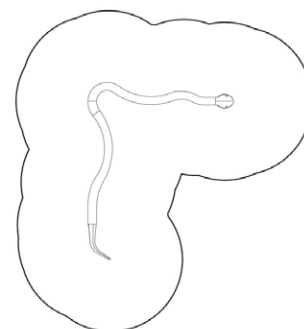
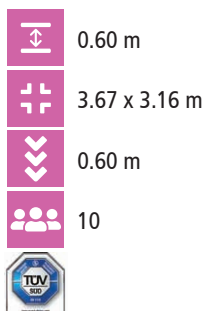

Green Mamba

Art. No. 4591-81GM

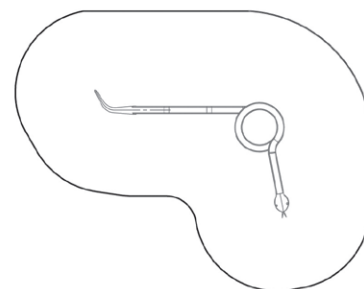
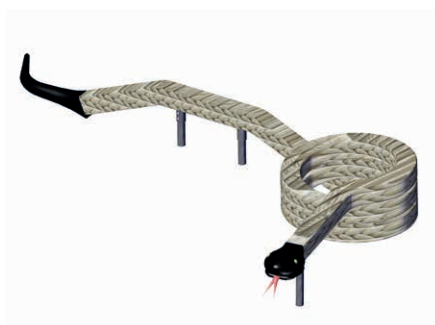
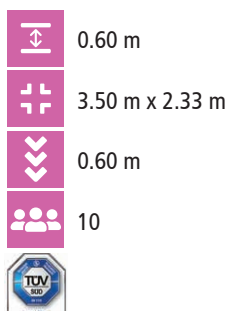

Q Spring-mounted Balancing Lines (Page 58)











Tightrope

Art. No. 4591-73



For symbol explanation see folding card at the back

-  0.65 m
-  6.20 x 1.00 m
-  36.00 m²
-  9.20 x 4.00 m
-  0.65 m
-  0.80 m³
-  15
- 

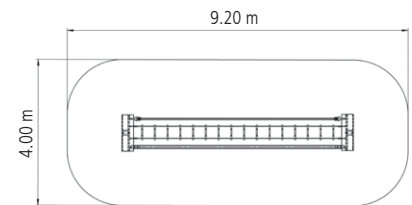

Equipment

2 solid stand constructions made of steel
T-shaped, hot-dip galvanized,
140/140 mm Square, no round tube

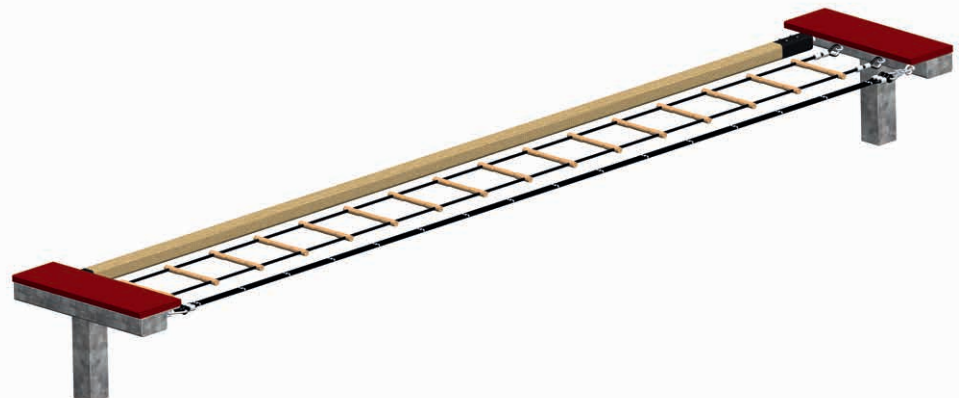







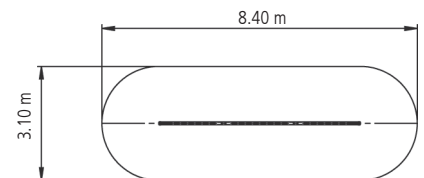

Slackbar

Art. No. 4591-80



For symbol explanation see folding card at the back



-  0.35 m
-  5.30 x 0.10 m
-  23.80 m²
-  8.40 x 3.10 m
-  0.35 m
-  0.65 m³
-  5



Equipment
Pole made of high quality fiberglass
mounted on special flat springs

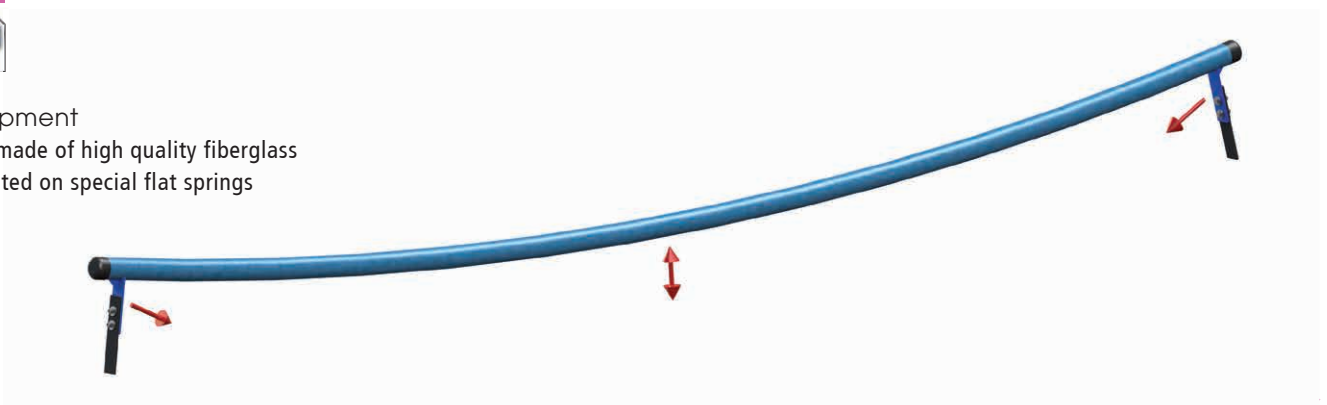











Spring-mounted Balancing Lines

Art. No. 4591-81



For symbol explanation see folding card at the back

-  0.65 m
-  9.85 x 0.65 m
-  40.00 m²
-  12.85 x 3.65 m
-  0.65 m
-  1.00 m³
-  10
- 

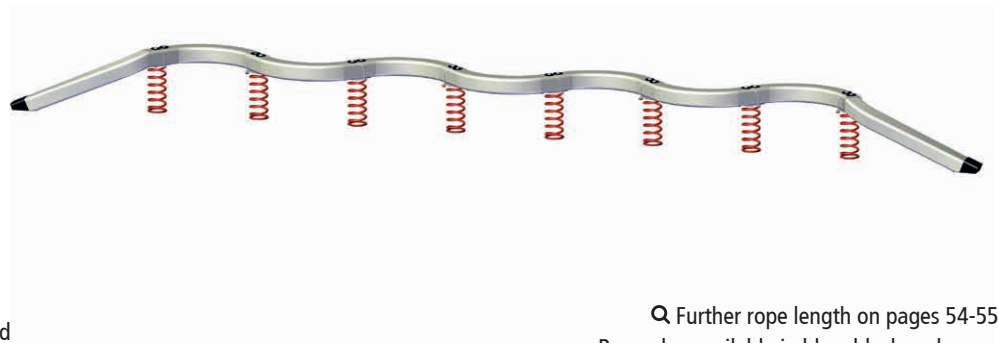
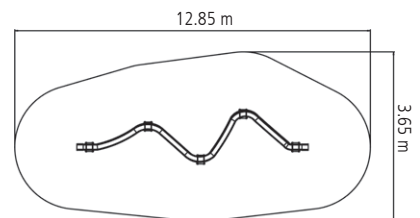

Equipment

8 ground anchors, hot-dip galvanized with steel spring (powder coated)

🔍 Further rope length on pages 54-55.
Rope also available in blue, black and green.











Slackmaster

Art. No. 4591-70-K



For symbol explanation see folding card at the back

-  1.65 m
-  3.50 x 3.10 m
-  29.50 m²
-  6.50 x 6.10 m
-  0.40 m
-  2.00 m³
-  15
- 

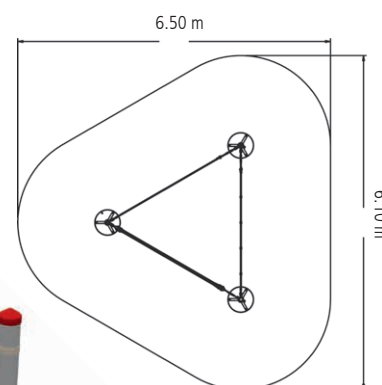
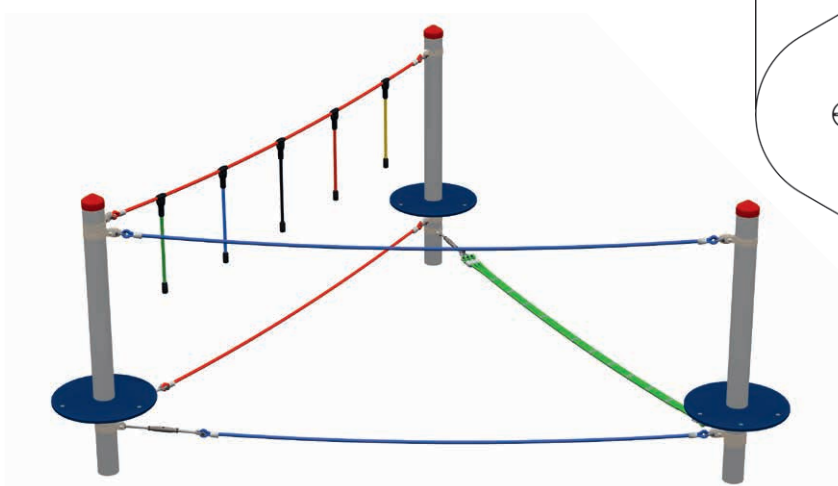

Equipment

- 3 Steel posts (Ø 102 mm), hot-dip galvanised, length 2.40 m, with plastic cap,
- 3 Foot plates made of HDPE (Ø 500 mm)

Each element is available separately and also in different lengths









Slackmaster Combination 1

Art. No. 4591-71 double version

Art. No. 4591-71-1 single version



For symbol explanation see folding card at the back

-  1.44 m
-  3.90 x 3.90 m
-  39.50 m²
-  6.90 x 6.90 m
-  0.50 m
-  1.60 m³
-  14



Equipment
 4 Steel posts (Ø 102 mm),
 hot-dip galvanised, length 2.00 m,
 with plastic cap,
 4 Foot plates made of HDPE (Ø 500 mm)



Diagram
 Art. No. 4591-71-1
 Simple version

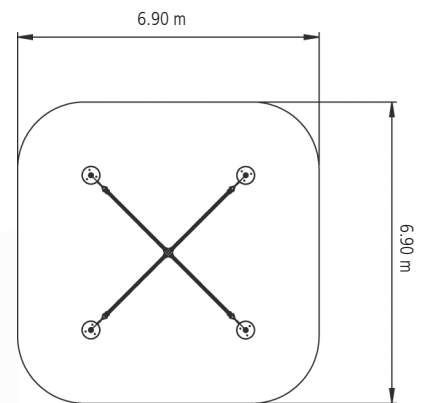
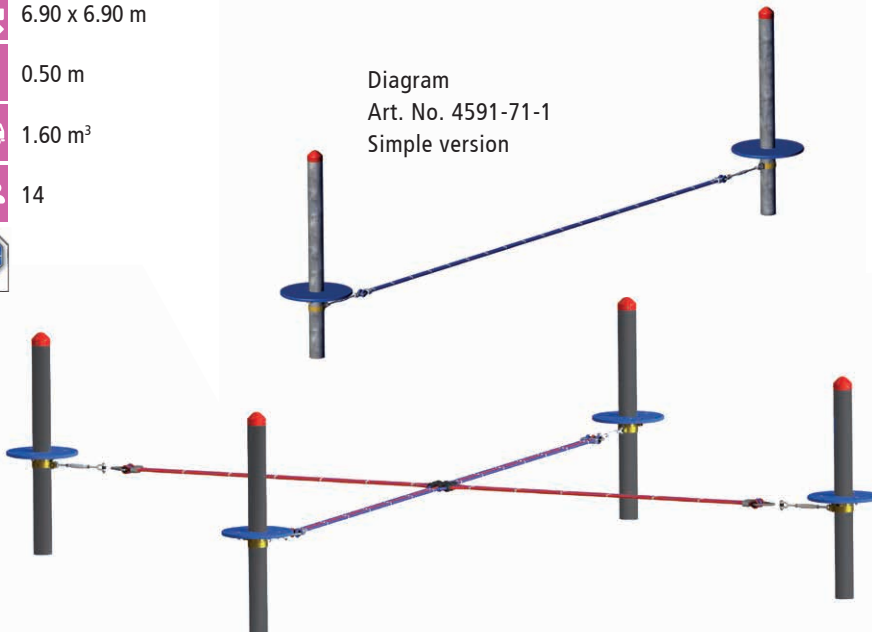









Slackmaster Combination 2

Art. No. 4591-72



For symbol explanation see folding card at the back

-  2.44 m
-  3.50 x 3.50 m
-  37.70 m²
-  6.50 x 6.50 m
-  1.60 m
-  1.60 m³
-  20
- 

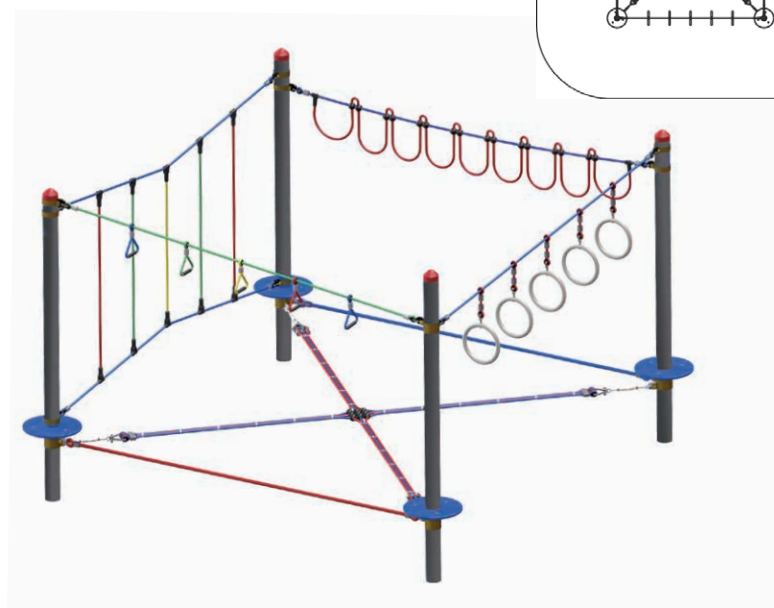
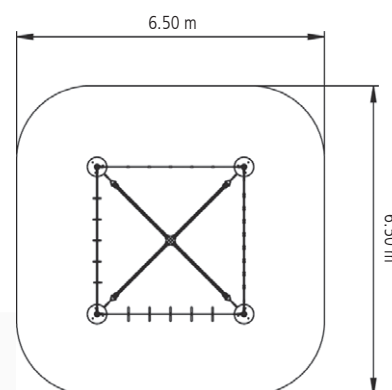

Equipment
 4 Steel posts (Ø 102 mm),
 hot-dip galvanised, length 3.40 m,
 with plastic cap,
 4 Foot plates made of HDPE (Ø 500 mm)











Eagles Nest Platform

Art. No. 4634-70



For symbol explanation see folding card at the back

-  2.25 m
-  4.45 x 4.00 m
-  40.75 m²
-  7.10 x 6.75 m
-  1.45 m
-  2.60 m³
-  20
- 

Equipment
4 Steel posts (Ø 102 mm),
hot-dip galvanised, length 3.00 m,
with plastic cap,
1 Steel centre post (Ø 193 mm),
hot-dip galvanised, length 2.50 m

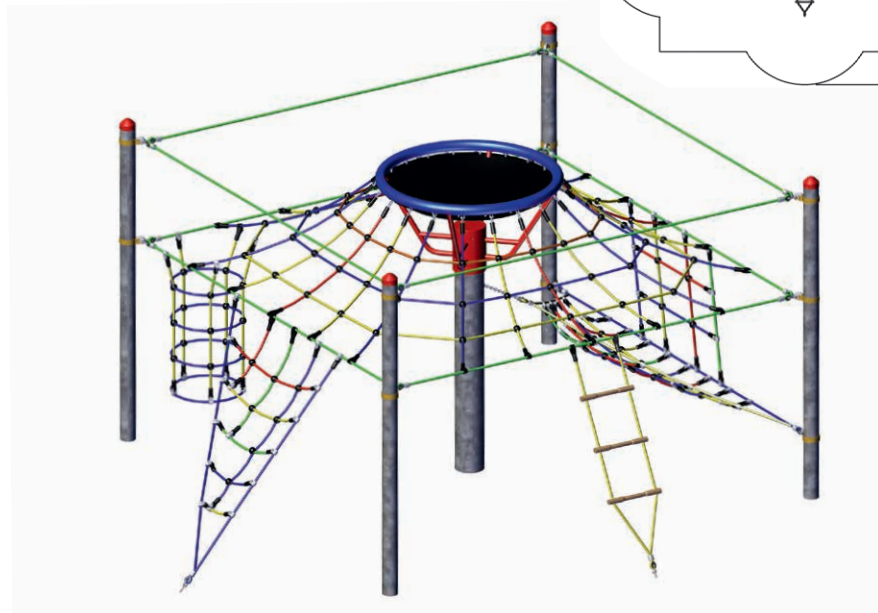
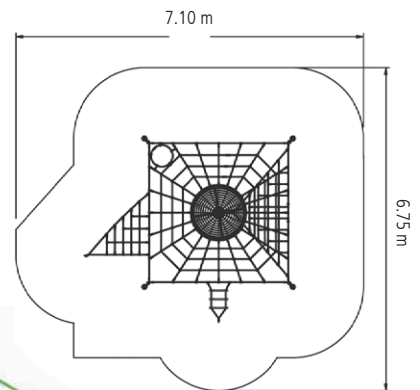









Witch's Coven Version 1

Art. No. 4594-50 Douglas fir posts (Ø 160 mm), with post shoes

Art. No. 4594-50S Steel posts (Ø 102 mm)



For symbol explanation see folding card at the back

-  1.75 m
-  6.40 x 6.25 m
-  54.00 m²
-  9.45 x 9.25 m
-  1.20 m
-  3.00 m³
-  20
- 

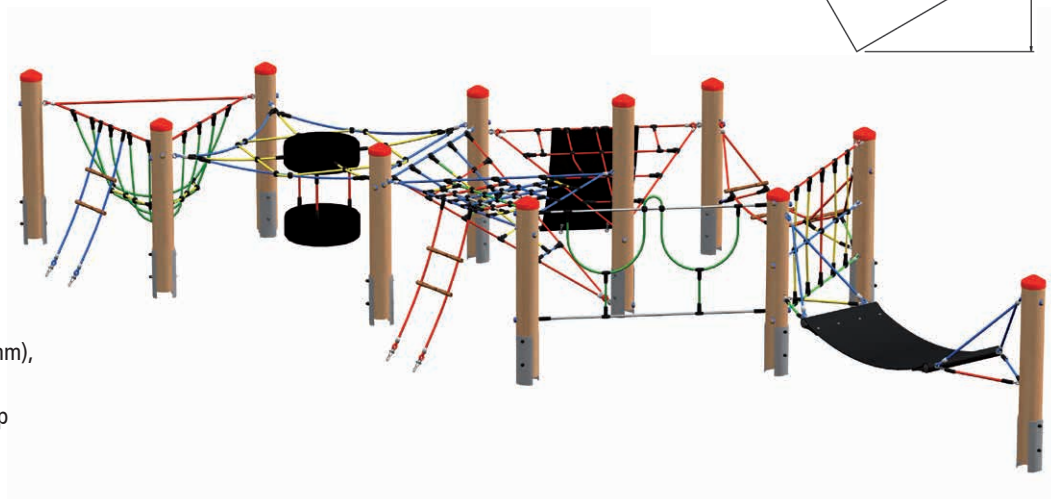
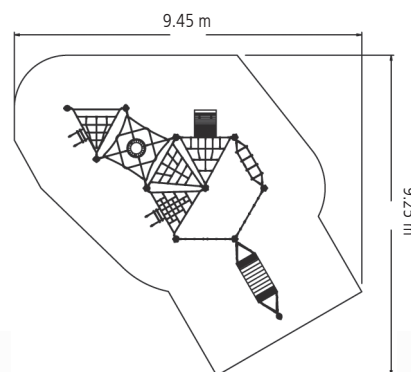

Equipment

11 Douglas fir posts (Ø 160 mm),
length 2.20 m to 2.60 m,
incl. post shoes and plastic cap









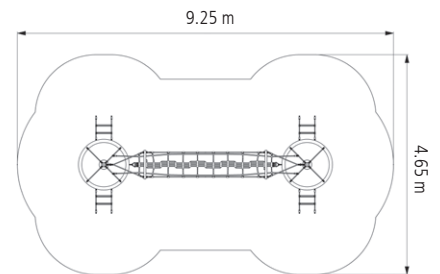

Tower Bridge

Art. No. 4960-11



For symbol explanation see folding card at the back



-  2.55 m
-  6.25 x 2.15 m
-  34.30 m²
-  9.25 x 4.65 m
-  0.90 m
-  1.90 m³
-  14
- 

Equipment
2 Steel posts (Ø 102 mm),
hot-dip galvanised, length 3.40 m,
with plastic cap

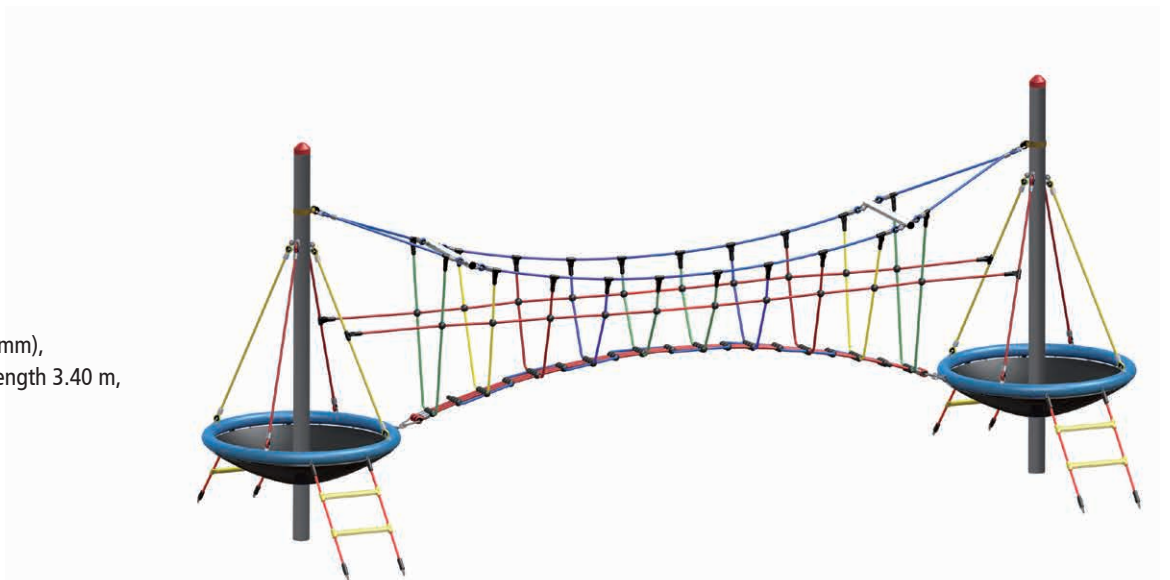

Tent Net

Art. No. 4639-10



For symbol explanation see folding card at the back

-  2.65 m
-  8.80 x 5.80 m
-  64.00 m²
-  11.00 x 7.90 m
-  2.20 m
-  2.10 m³
-  20
- 

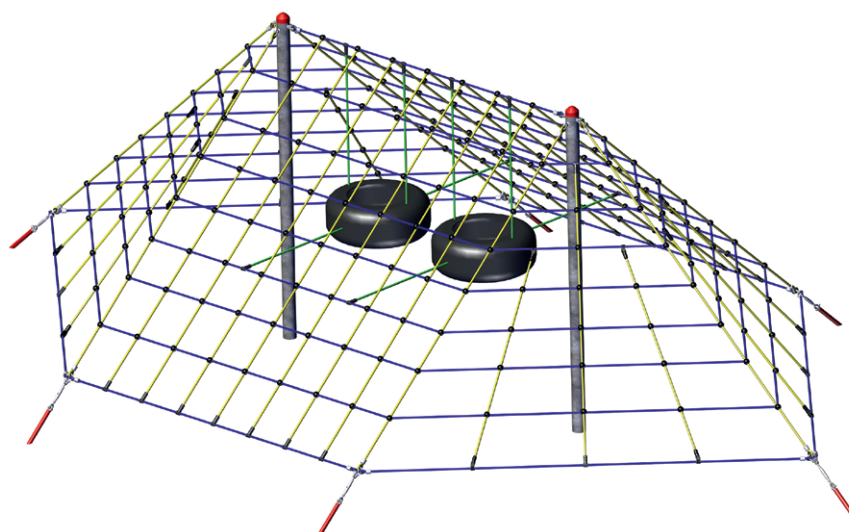
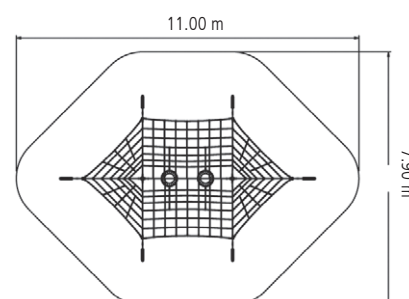

Equipment
 2 Steel posts (Ø 102 mm),
 hot-dip galvanised, length 3.50 m,
 with plastic cap

RISING UP!





ROPE PLAY EQUIPMENT

For children from the age of 6

HUCK play and climbing equipment for children from the age of 6 is perfect for schools. During breaktimes they can let off steam properly on our climbing and swinging options and can then concentrate much better in lessons after. The multitude of play options the equipment provides promotes creativity and the child's visual motor skills.

PRODUCT-HIGHLIGHTS



Climb and Chill
| 74 |



Hexagon Tower
| 72 |



Bird's Nest Tree "Dragon"
| 88 |





Ellipsis, spinning

Art. No. 20.01.170



For symbol explanation see folding card at the back









-  2.95 m
-  Ø 2.30 m
-  38.50 m²
-  Ø 7.00 m
recommended Ø 10.00 m
-  2.05 m
-  0.70 m³
-  15
- 

Spinning Mushroom

Art. No. 4530-60



For symbol explanation see folding card at the back

-  2.45 m
-  Ø 2.30 m
-  50.00 m²
-  Ø 8.00 m
-  1.60 m
-  1.00 m³
-  8
- 

Equipment
 1 Steel post (Ø 160 mm),
 hot-dip galvanised,
 length 3.00 m, with cap

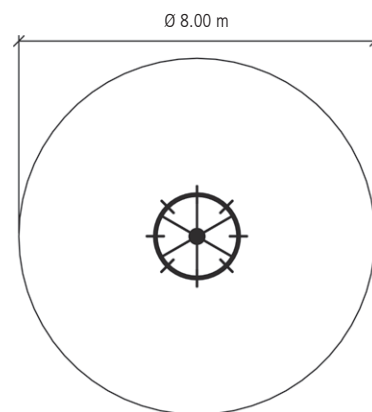











Bow Net

Art. No. 4960-15



For symbol explanation see folding card at the back

-  3.05 m
-  5.15 x 2.70 m
-  24.90 m²
-  6.70 x 5.10 m
-  2.20 m
-  3.10 m³
-  11
- 

Equipment
2 Steel posts (Ø 159 mm),
hot-dip galvanised, length 4.00 m / 3.00 m,
with plastic cap

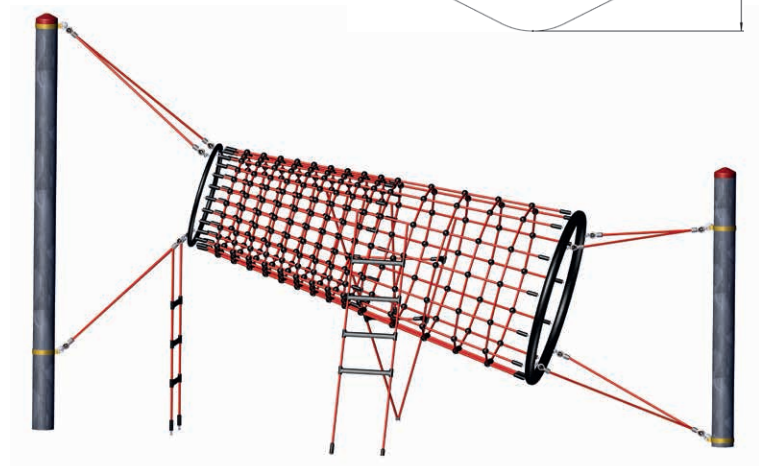
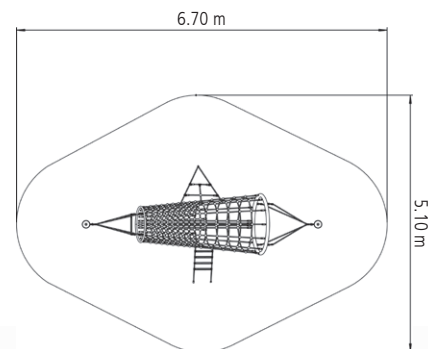









Rubber Jumper

Art. No. 4951



For symbol explanation see folding card at the back

-  0.70 m
-  8.10 x 1.50 m
-  42.40 m²
-  11.10 x 4.00 m
-  0.70 m
-  3.20 m³
-  12
- 

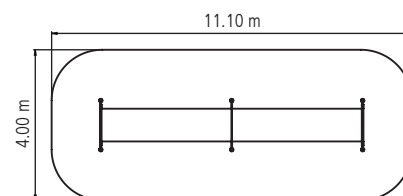

Equipment

6 Steel posts (Ø 102 mm),
hot-dip galvanised, length 1.50 m / 1.40 m,
with plastic cap











Hexagon Tower

Art. No. 4631-50



For symbol explanation see folding card at the back

-  4.00 m
-  Ø 9.85 m
-  76.00 m²
-  Ø 9.85 m
-  3.00 m
-  12.00 m³
-  45
- 

Equipment

6 Robinia wood posts (Ø 250 – 350 mm), Splinter free, as grown, length 5.00 m, mitre top at 100 mm, with steel post shoes

Ø 9.85 m

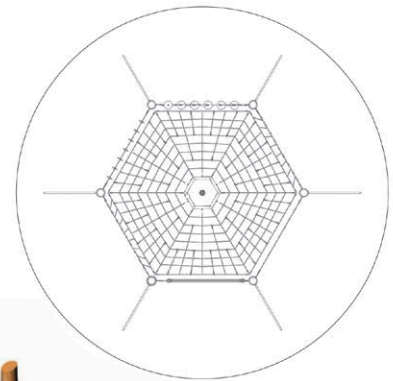

Please note!

The space required for foundations (assembly space) is bigger than the minimum space requirement for the equipment.









Climbing Glasses

Art. No. 4580-5K



For symbol explanation see folding card at the back

-  2.00 m
-  6.25 x 5.05 m
-  68.20 m²
-  9.25 x 8.25 m
-  2.00 m
-  25
- 

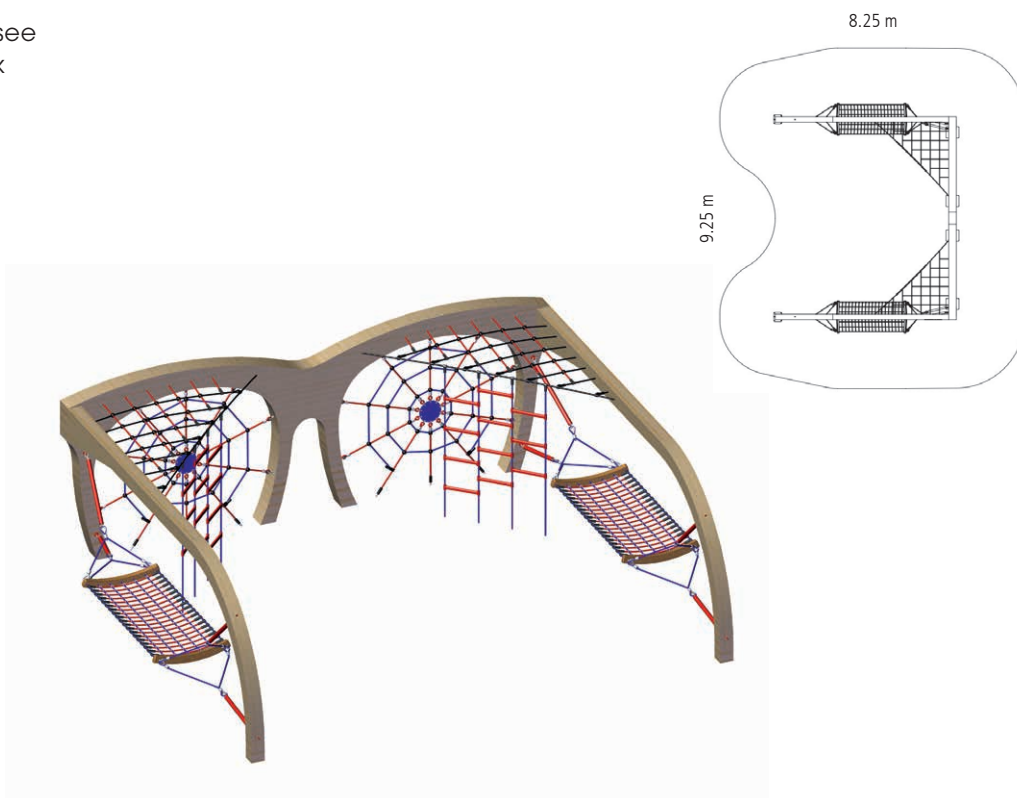











NEW FOR 2022

Climb and Chill

Art. No. 6200



For symbol explanation see folding card at the back

-  2.40 m
-  4.90 x 2.15 m
-  47.40 m²
-  8.10 m x 6.35 m
-  2.40 m
-  3.30 m³
-  24
- 

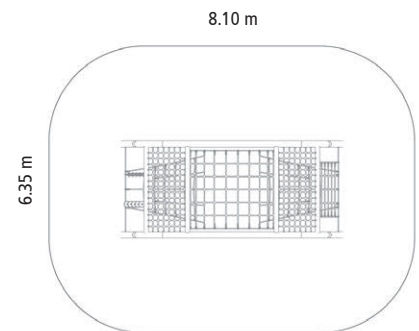

Play equipment as shown in 3D image











Climbing Palm

Art. No. 4653



For symbol explanation see folding card at the back

-  6.00 m
-  5.80 x 11.80 m
-  97.20 m²
-  12.85 x 8.90 m
-  2.90 m
-  3.00 m³
-  35
- 

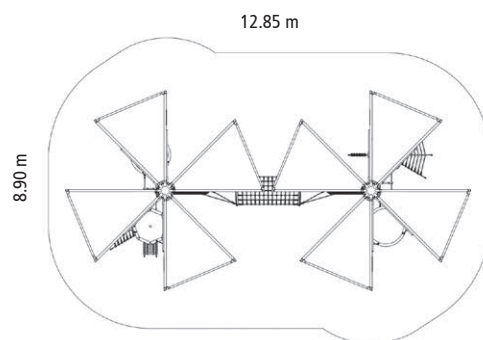



Climbing Whirl, spinning

Art. No. 20.01.130S

For symbol explanation see folding card at the back

-  4.20 m
-  Ø 3.50 m
-  50.00 m²
-  Ø 8.00 m
recommended Ø 11.00 m
-  2.50 m
-  1.00 m³
-  20
- 











Hally-Gally

Midi Climbing Tepee

Art. No. 4587-22



For symbol explanation see folding card at the back

-  3.65 m
-  3.40 x 3.40 m
-  32.40 m²
-  5.85 x 5.85 m
-  2.20 m
-  1.60 m³
-  25
- 

Equipment
4 Steel posts (Ø 102 mm),
hot-dip galvanised, length 5.00 m

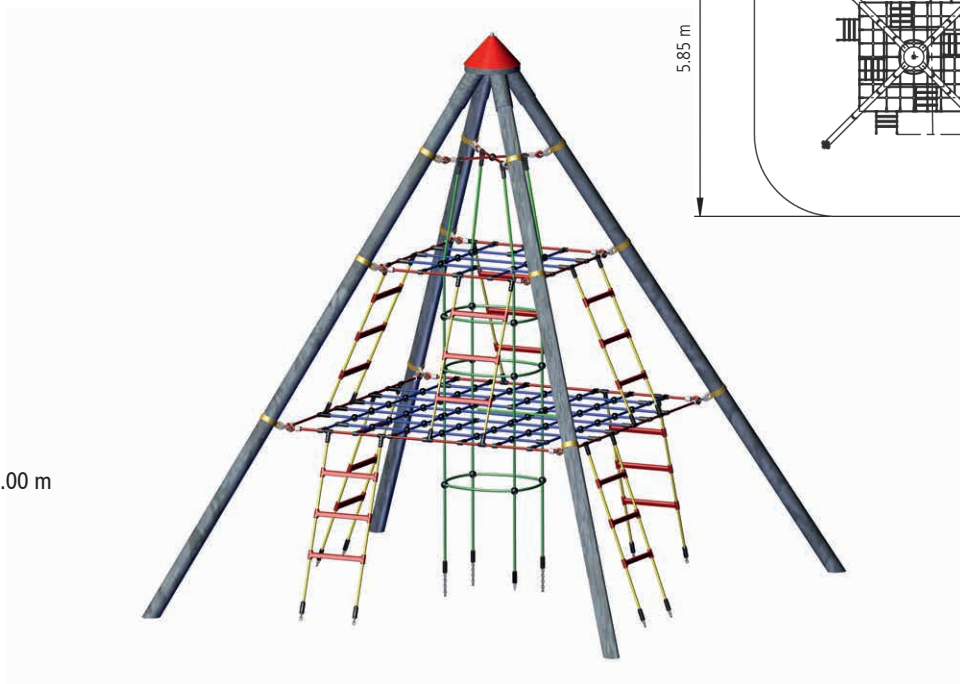



Large Climbing Pyramid, spinning

Art. No. 20.01.060S

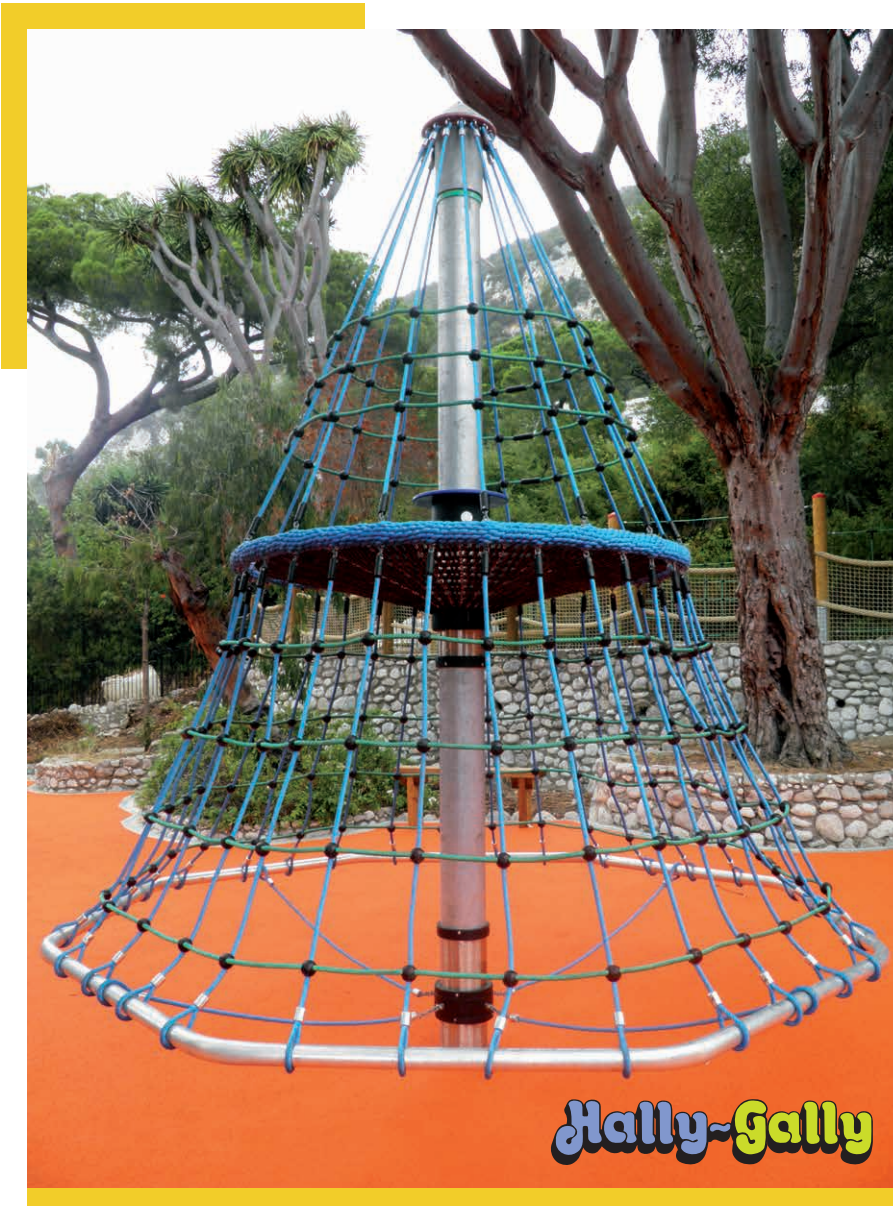

For symbol explanation see folding card at the back









-  4.20 m
-  Ø 3.50 m
-  50.00 m²
recommended 95.00 m²
-  Ø 8.00 m
recommended Ø 11.00 m
-  2.80 m
-  1.00 m³
-  20
- 

Olive Tree

Art. No. 4652-24



For symbol explanation see folding card at the back

-  7.20 m
-  6.60 x 6.60 m
-  62.00 m²
-  9.50 x 9.50 m
-  3.00 m
-  2.10 m³
-  45
- 

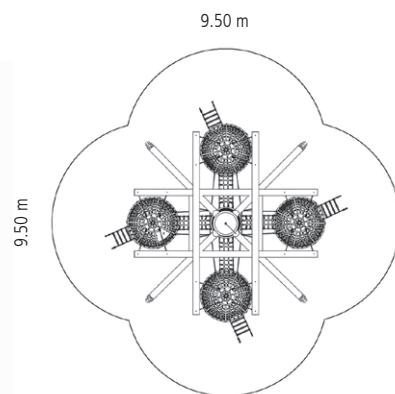











"Black Beard" Pirate Ship

Art. No. 4687-25 wood crossbeams

Art. No. 4687-25S steel crossbeams



For symbol explanation see folding card at the back

-  5.20 m
-  11.70 x 3.95 m
-  71.30 m²
-  15.15 x 6.90 m
-  2.70 m
-  3.60 m³
-  35
- 

Equipment
1 Steel post (Ø 160 mm),
hot-dip galvanised,
length 6.00 m
3 Steel posts (Ø 102 mm),
length 3.50 m
with plastic cap

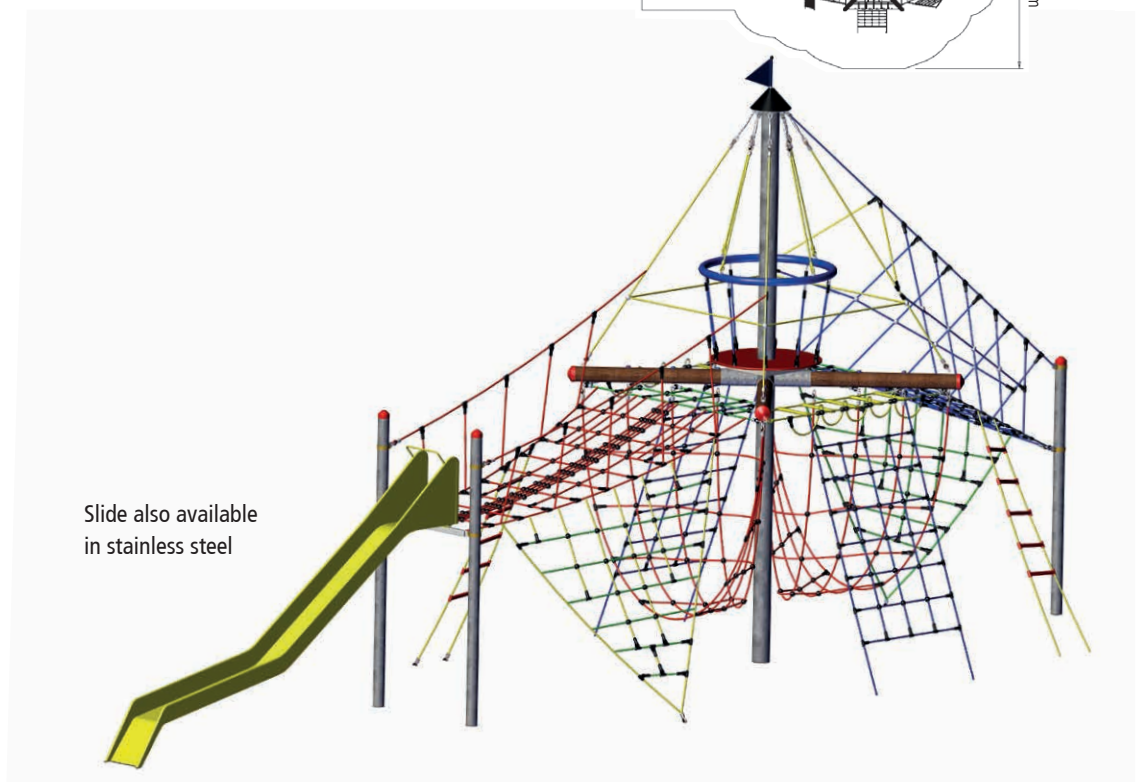
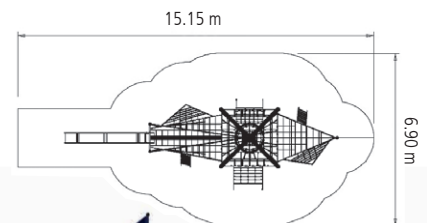

Slide also available
in stainless steel











Pirate Tower

Art. No. 4687-20 wood crossbeams

Art. No. 4687-20S steel crossbeams



For symbol explanation see folding card at the back

-  5.20 m
-  3.75 x 2.55 m
-  44.40 m²
-  7.00 x 7.00 m
-  2.70 m
-  1.70 m³
-  25
- 

Equipment
 1 Steel post (Ø 160 mm),
 hot-dip galvanised,
 length 6.00 m,
 4 steel cross-beams (Ø 139.7 mm),
 length 1.64 m, with plastic cap

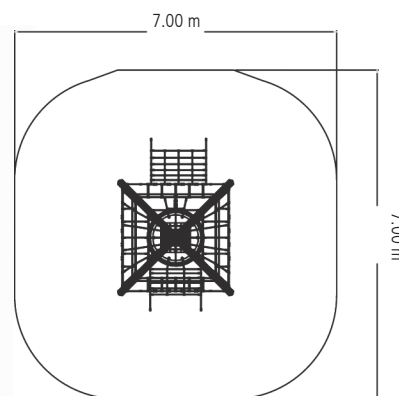
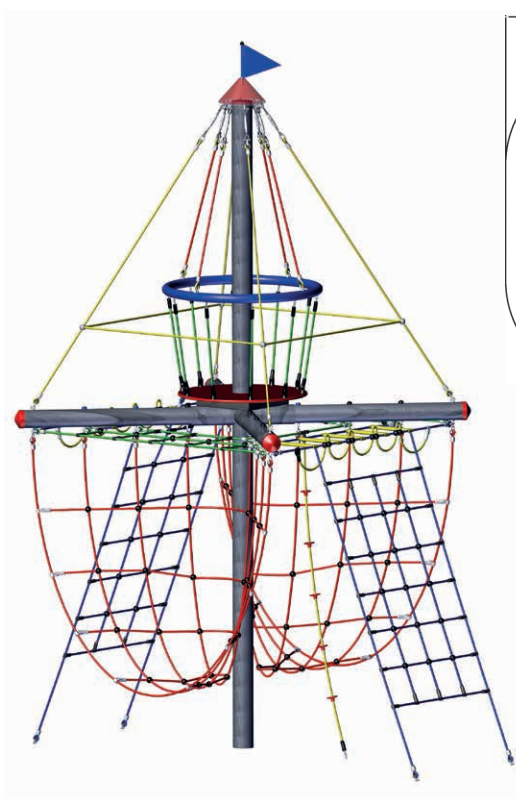











Space Capsule, spinning

Art. No. 20.01.020S



For symbol explanation see
folding card at the back









-  3.40 m
-  Ø 3.50 m
-  50.25 m²
-  Ø 8.00 m
recommended Ø 11.00 m
-  2.00 m
-  1.00 m³
-  19
- 

Hourglass

Art. No. 4592



For symbol explanation see folding card at the back

-  5.15 m
-  Ø 3.05 m
-  37.70 m²
-  Ø 7.00 m
-  max. 3.00 m
-  1.40 m³
-  19
- 

Equipment
 1 Steel post (Ø 160 mm),
 hot-dip galvanised,
 length 6.00 m

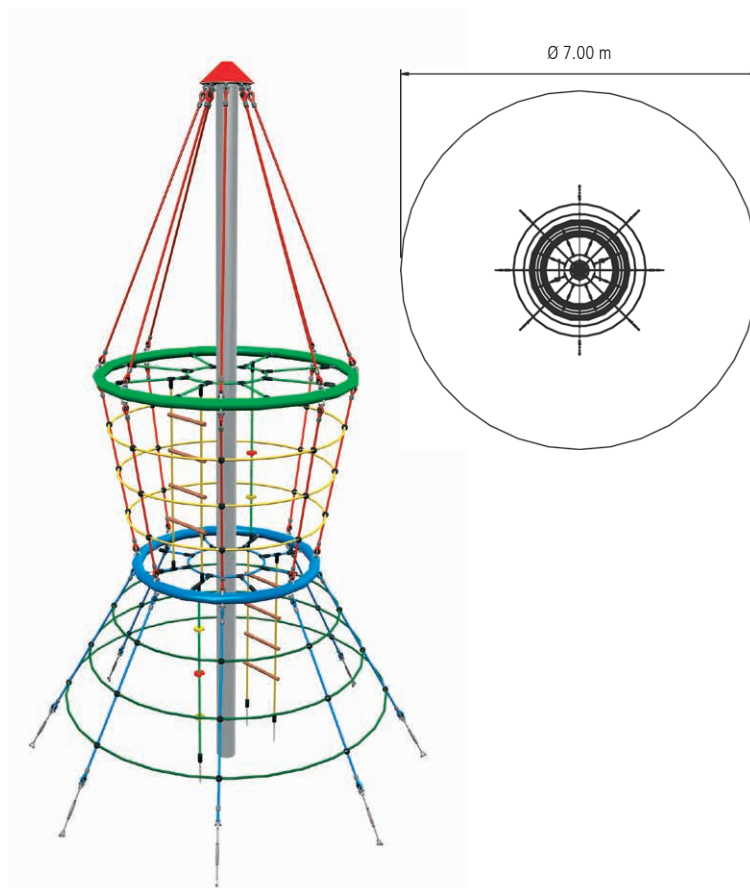









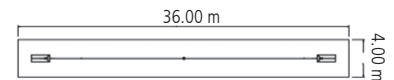

Aerial Runway, with buried ground anchor

Art. No. 4581B



For symbol explanation see folding card at the back



-  3.55 m
-  0.16 x 33.10 m
-  132.60 m²
-  36.00 x 4.00 m
-  1.50 m
-  6.80 m³
-  1
- 

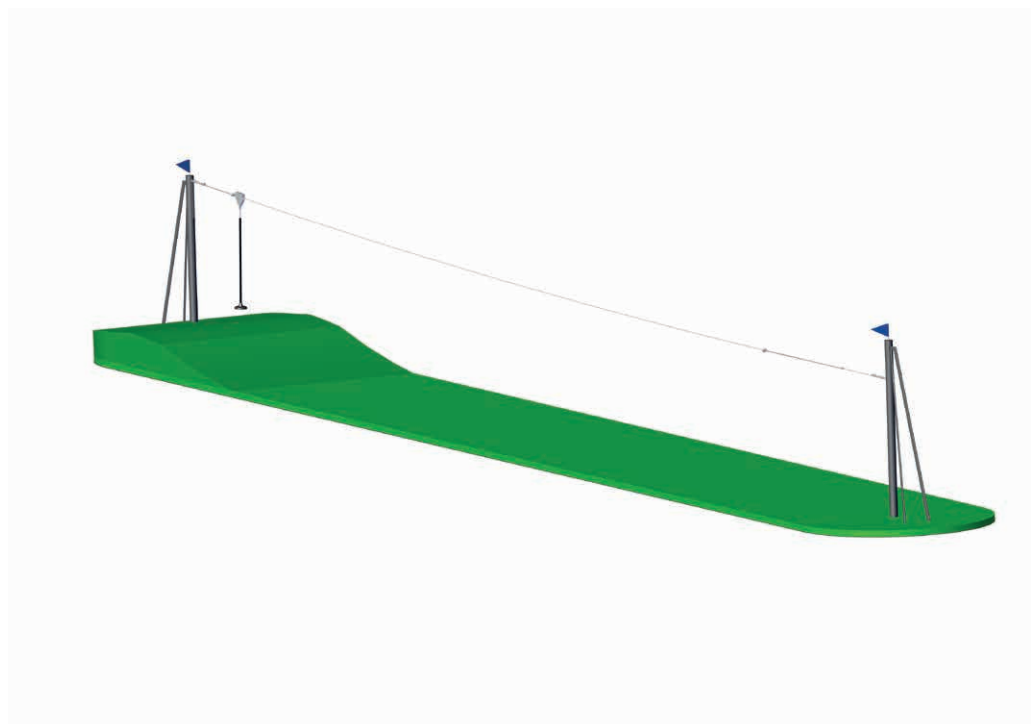







Serpent - The Snake

Art. No. 20.02.000



Picture shows standard version

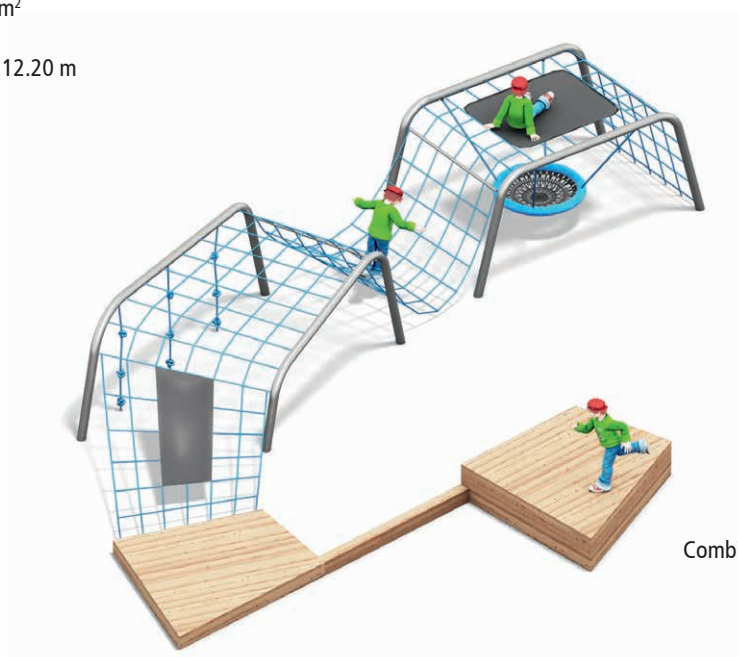

For symbol explanation see folding card at the back

-  1.90 m
-  8.90 x 12.00 m
-  135.00 m²
-  14.95 x 12.20 m
-  1.90 m
-  35
- 

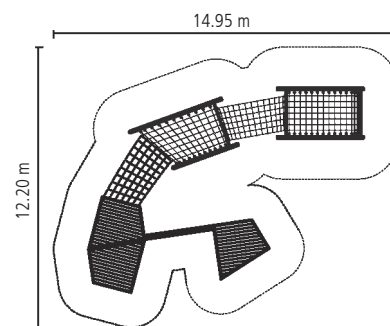

Combination example



-  Ready-made foundations are included in delivery
-  Made from stainless steel tubes











Tipi

Art. No. 20.02.137



For symbol explanation see folding card at the back

-  5.20 m
-  Ø 4.50 m
-  75.30 m
-  Ø 9.80 m
-  2.90 m
-  2.00 m
-  34
- 







Tower Carousel, spinning

Art. No. 20.01.150S



For symbol explanation see folding card at the back

-  4.20 m
-  Ø 2.00 m
-  50.20 m²
-  Ø 8.00 m
recommended Ø 11.00 m
-  2.80 m
-  1.00 m³
-  12
- 











Bird's Nest Tree "Drago"

Art. No. 4652-70



For symbol explanation see folding card at the back

-  5.95 m
-  Ø 4.55 m
-  54.00 m²
-  Ø 8.30 m
-  2.60 m
-  4.80 m³
-  28
- 

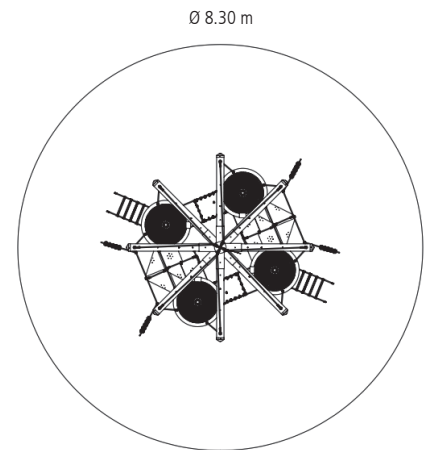







Bird's Nest Tree

Art. No. 4652 wood crossbeams

Art. No. 4652S steel crossbeams



For symbol explanation see folding card at the back

-  5.95 m
-  Ø 7.70 m
-  81.00 m²
-  Ø 10.20 m
-  2.80 m
-  3.20 m³
-  37
- 

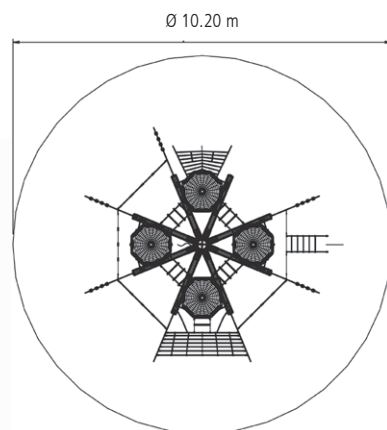

- Q Mini Bird's Nest Tree (Page 17)
- Q Bird's Nest Tree Midi (Page 94)

Hot-dipped galvanised steel cross beams are available upon request
Further elements such as a slide can be added.











Eagles Nest Tree

Art. No. 4652-40 wood crossbeams

Art. No. 4652-40S steel crossbeams



For symbol explanation see folding card at the back

-  5.95 m
-  Ø 4.00 m
-  52.80 m²
-  Ø 8.20 m
-  2.95 m
-  2.40 m³
-  35
- 

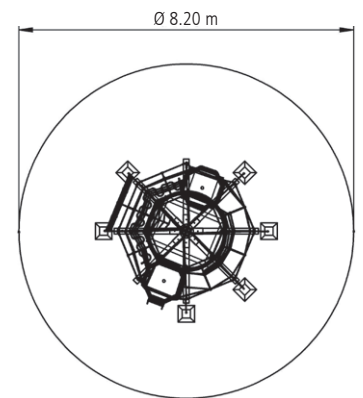
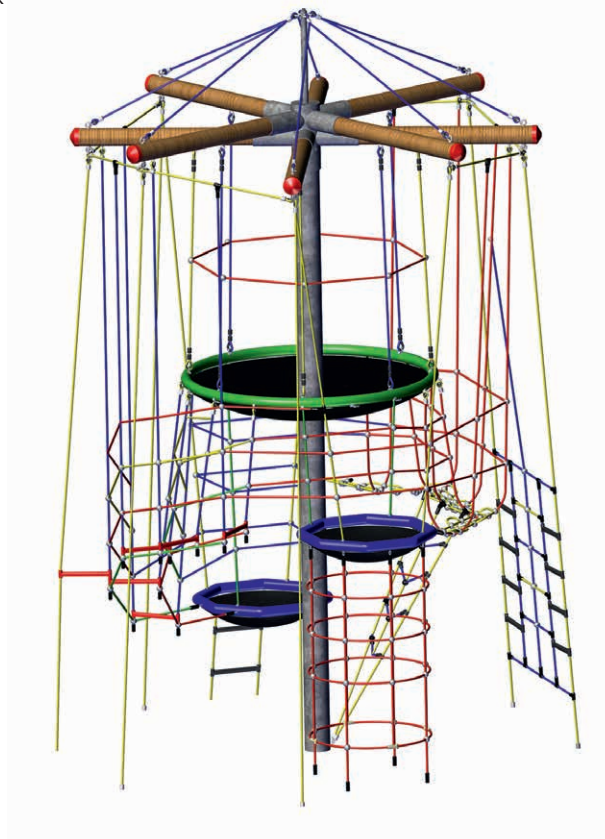

Hot-dipped galvanised steel cross beams are available upon request. See right hand picture above. Further elements such as a slide can be added.











Bird's Nest Tree "Laola"

Art. No. 4652-60



For symbol explanation see folding card at the back

-  5.95 m
-  7.25 x 7.15 m
-  48.20 m²
-  9.50 x 7.95 m
-  2.50 m
-  7.60 m³
-  45
- 

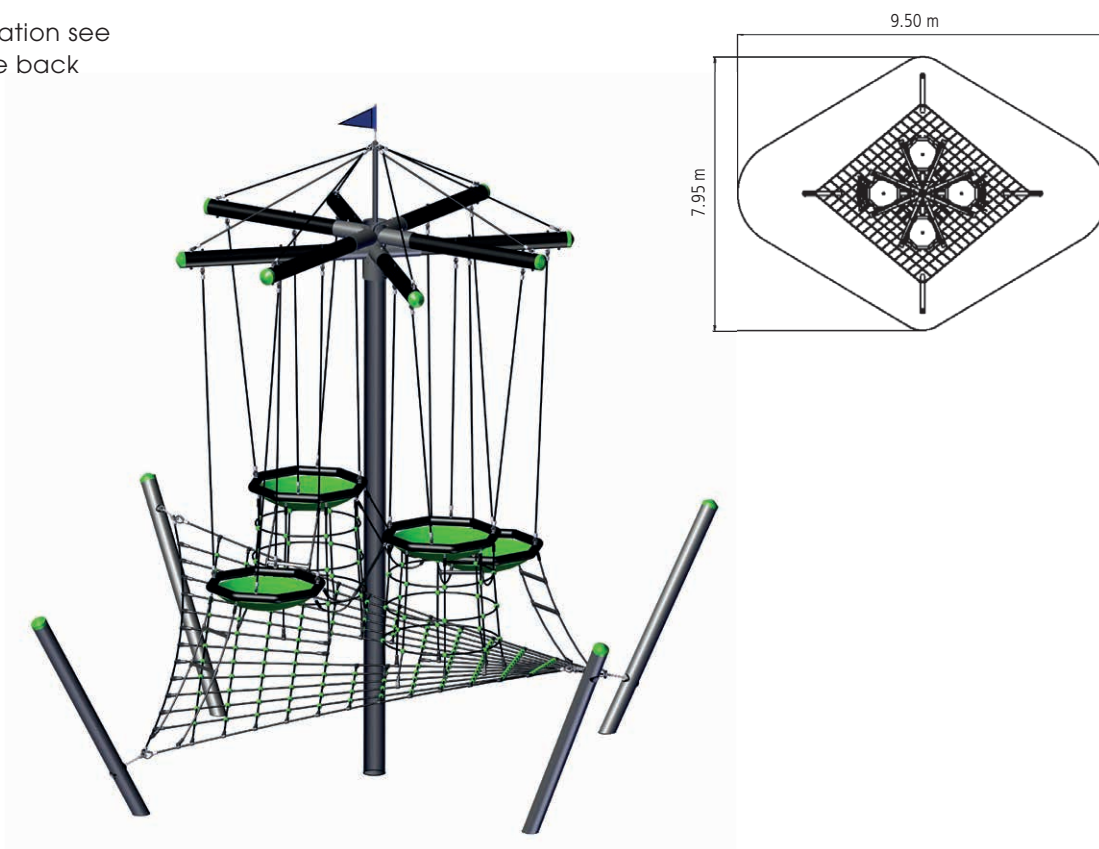



Bird's Nest Tree, with bridge and slide

Art. No. 4652-2 Wood crossbeams

Art. No. 4652-2S Steel crossbeams



For symbol explanation see folding card at the back

-  5.95 m
-  13.00 x 7.10 m
-  101.00 m²
-  16.45 x 10.20 m
-  2.80 m
-  4.40 m³
-  42
- 

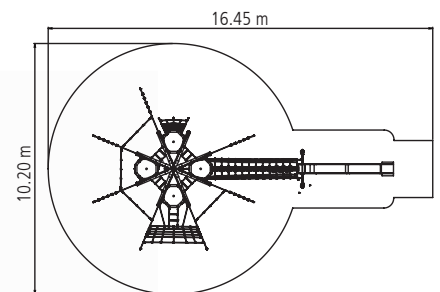
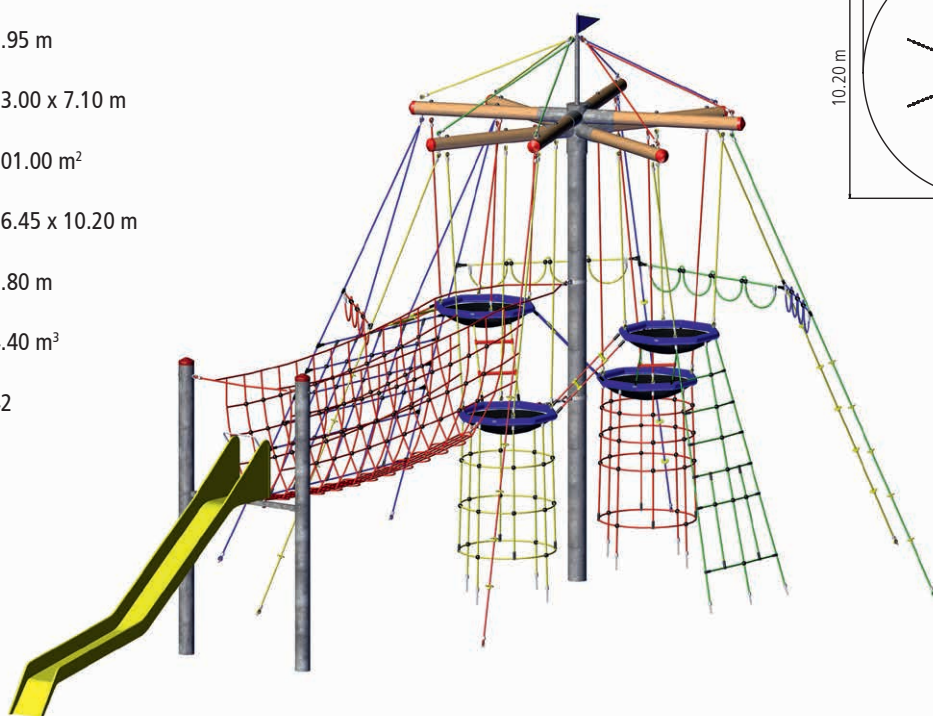





Bird's Nest Tree, with bridge and spiral slide

Art. No. 4652-3 Wood crossbeams

Art. No. 4652-3S Steel crossbeams



For symbol explanation see folding card at the back

-  5.95 m
-  12.65 x 7.30 m
-  114.30 m²
-  16.50 x 11.00 m
-  2.80 m
-  4.75 m³
-  42
- 

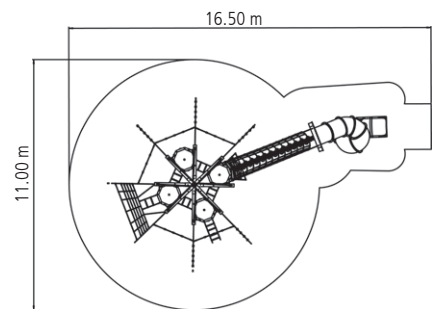
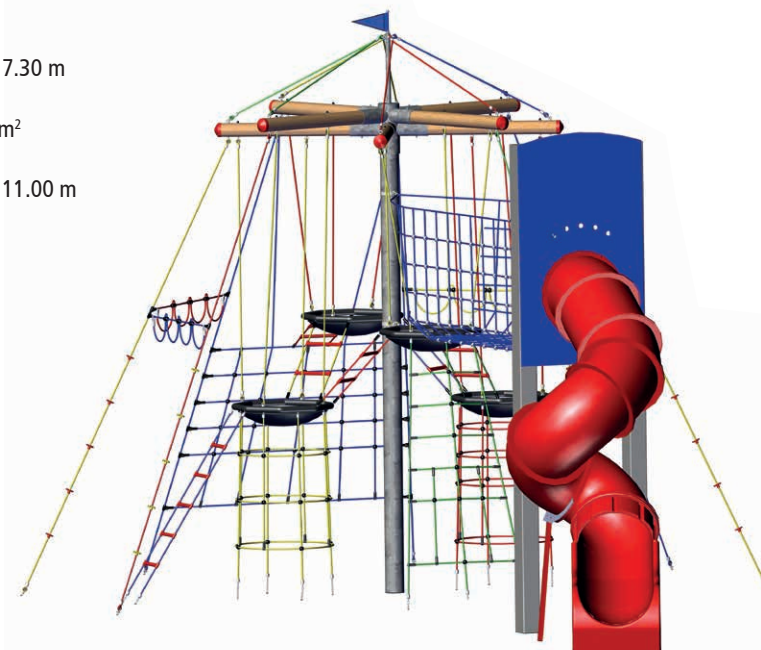

Hot-dipped galvanised steel cross beams are available upon request. Upon request also available with straight slide.











Bird's Nest Tree Midi

Art. No. 4652-10 Wood crossbeams

Art. No. 4652-10S Steel crossbeams



For symbol explanation see folding card at the back

-  5.20 m
-  Ø 3.65 m
-  44.20 m³
-  Ø 7.50 m
-  2.00 m
-  3.00 m³
-  35
- 

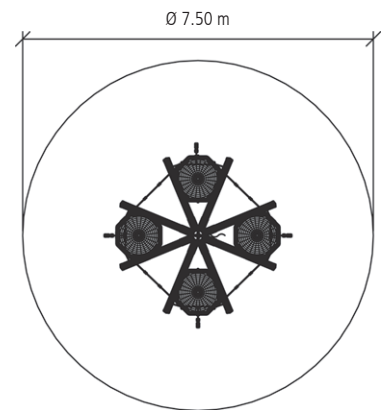

Q Mini Bird's Nest Tree (Page 17)

Q Bird's Nest Tree (Page 89)

Hot-dipped galvanised steel cross beams are available upon request. Further elements such as a slide can be added.









Bird's Nest Tower "Black Forest"-Combi

Art. No. 4652-23



For symbol explanation see folding card at the back

-  6.90 m
-  10.40 x 8.20 m
-  127.00 m²
-  13.70 x 12.10 m
-  2.95 m
-  5.85 m³
-  107
- 

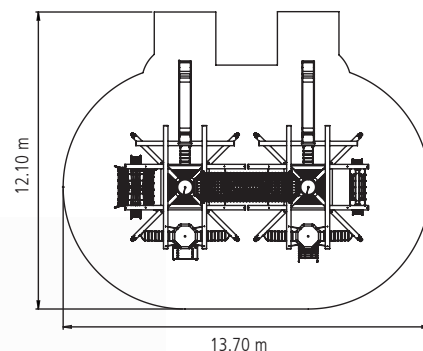











Bird's Nest Tower

Art. No. 4652-20S, with steel posts



For symbol explanation see folding card at the back

-  6.90 m
-  7.10 x 6.85 m
-  78.50 m³
-  Ø 10.00 m
-  2.90 m
-  3.50 m³
-  32
- 

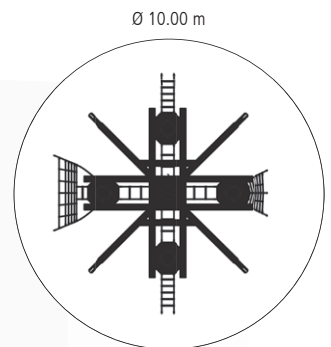
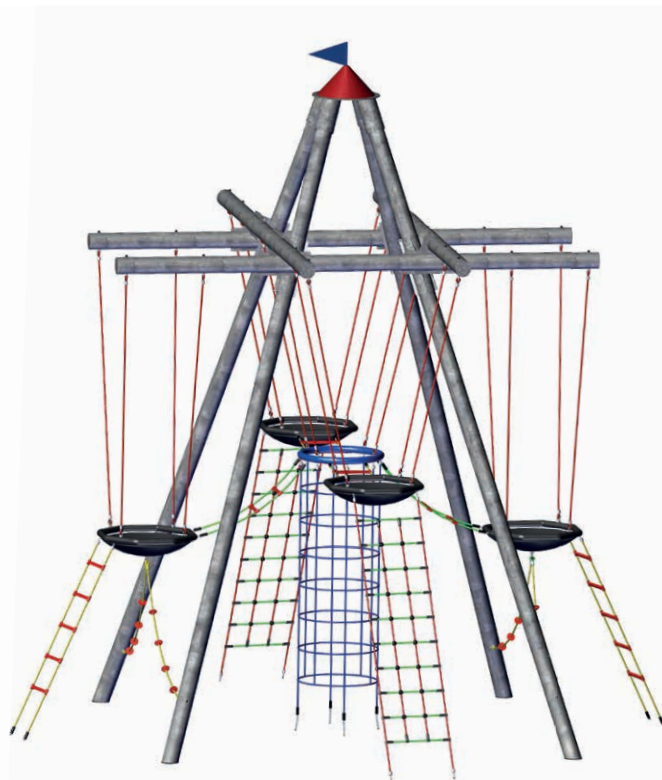









Bird's Nest Tower

Art. No. 4652-20, with wood posts



For symbol explanation see folding card at the back

-  6.90 m
-  7.10 x 6.85 m
-  78.50 m²
-  Ø 10.00 m
-  2.90 m
-  3.50 m³
-  32
- 

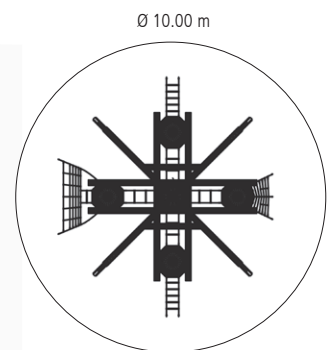

Q "Fortuna" Bird's Nest Tower (Page 18)

Q Olive Tree (Page 79)





Bird's Nest Tower "Black Forest"

Art. No. 4652-21S, with steel posts



For symbol explanation see folding card at the back

-  6.90 m
-  5.60 x 8.70 m
-  83.10 m²
-  9.90 x 12.10 m
-  3.00 m
-  3.00 m³
-  64
- 

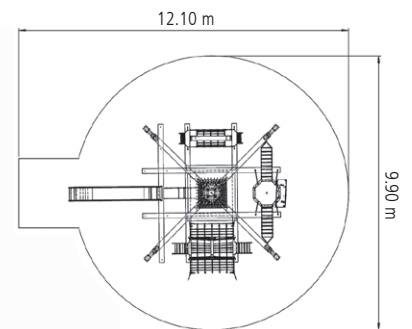
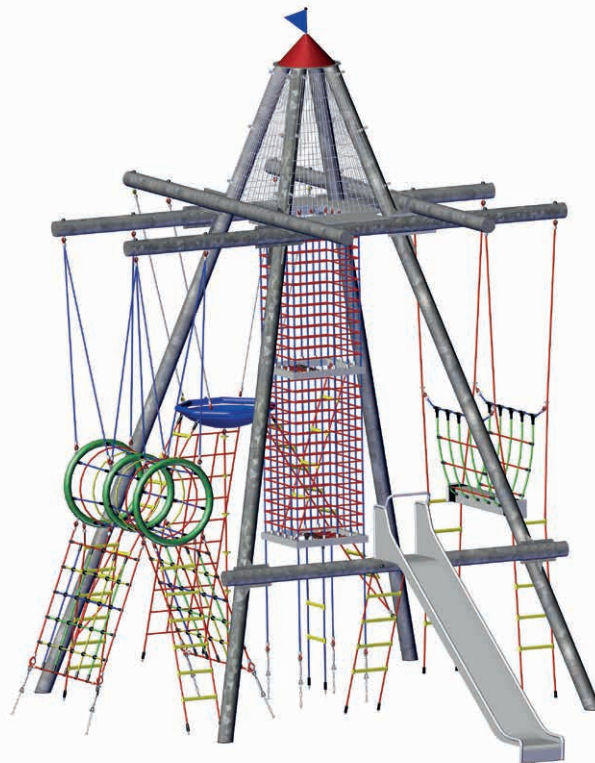









Bird's Nest Tower "Black Forest"

Art. No. 4652-21, with wood posts



For symbol explanation see folding card at the back

-  6.90 m
-  5.60 x 8.70 m
-  83.10 m²
-  9.90 x 12.10 m
-  3.00 m
-  3.00 m³
-  64
- 

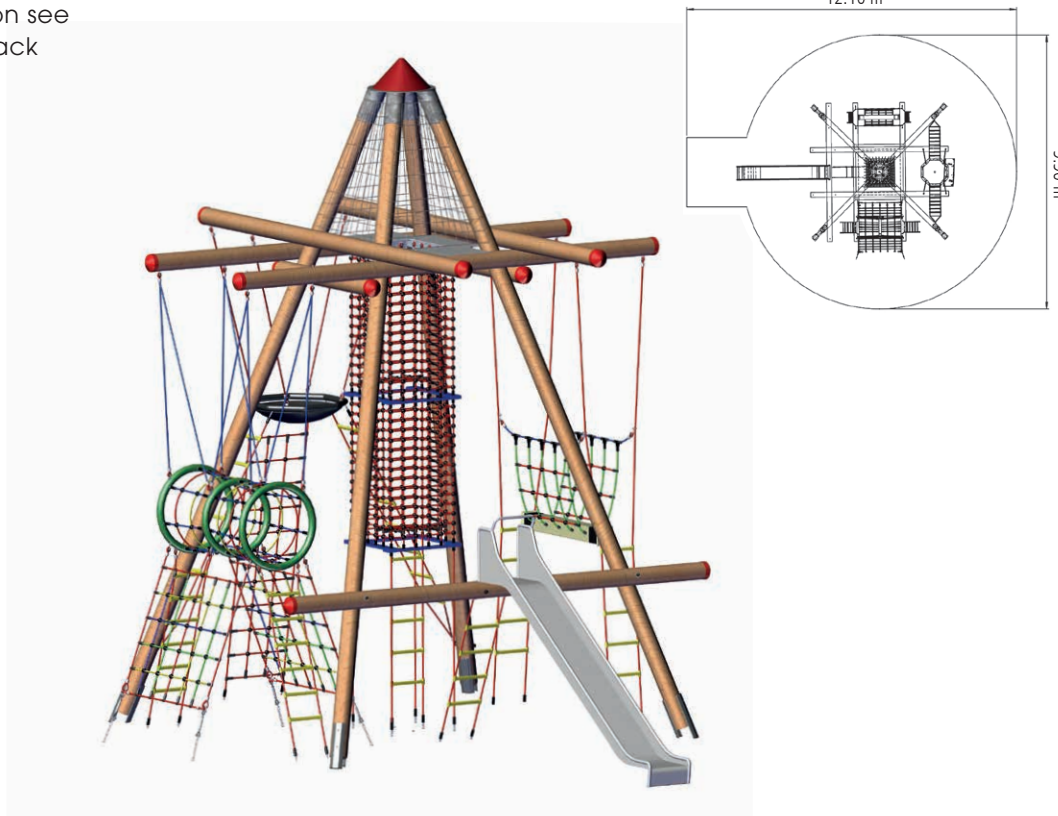









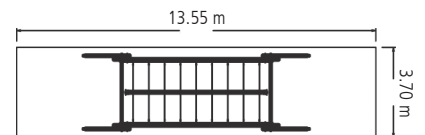

Viking Swinger

Art. No. 4585-60



For symbol explanation see folding card at the back



-  3.50 m
-  9.40 x 3.00 m
-  50.00 m²
-  13.55 x 3.70 m
-  1.80 m
-  5.70 m³
-  10
- 

Please note!

The space required for foundations (assembly space) is bigger than the minimum space requirement for the equipment.

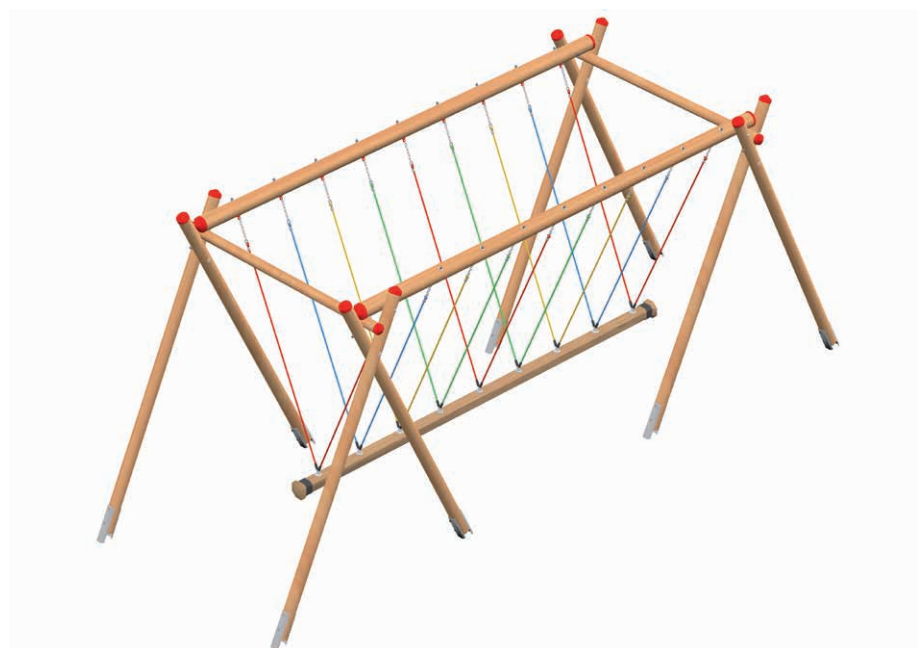









Dragon Swinger

Art. No. 4585-10



For symbol explanation see folding card at the back

-  5.25 m
-  7.05 x 15.90 m
-  155.75 m²
-  17.50 x 8.90 m
-  1.50 m
-  8.90 m³
-  13
- 

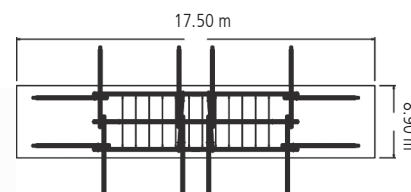
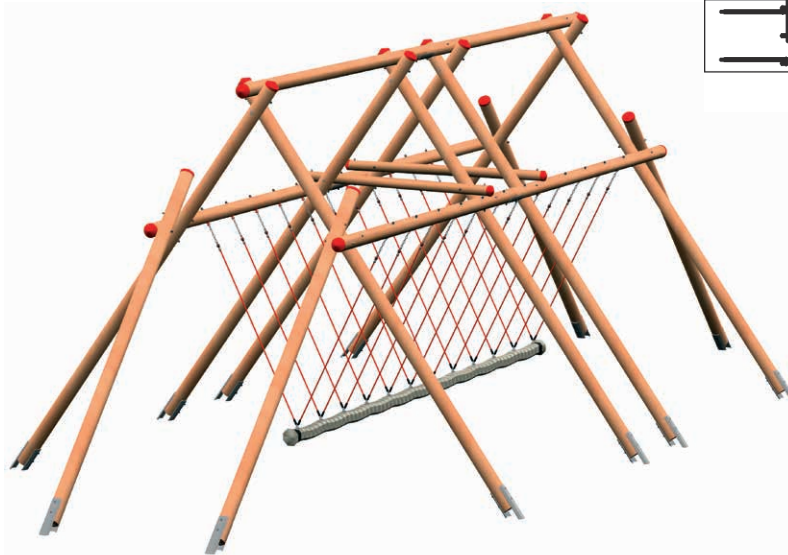

👍 The piece of equipment for the biggest stampede! Successfully used in schools and parks for many years now.

Please note!

The space required for foundations (assembly space) is bigger than the minimum space requirement for the equipment.

Separately as an attachment too (Rope-end swing incl. suspension Ropes and bearing) for your stand-alone designs.



Victory Swinger

Art. No. 4585-50



For symbol explanation see folding card at the back

-  2.90 m
-  7.75 x 3.65 m
-  42.00 m²
-  12.50 x 3.50 m
-  1.75 m
-  1.60 m³
-  9
- 
- 

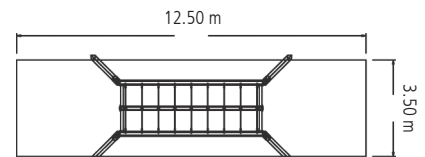

Please note!

The space required for foundations (assembly space) is bigger than the minimum space requirement for the equipment.



Gondolar Swinger









Art. No. 4585S, with steel posts (Ø 102 mm)

Art. No. 4585PS, with wood posts (Ø 180 mm), with post shoes



Design here with Douglas fir posts

For symbol explanation see folding card at the back

-  2.80 m
-  3.75 x 2.20 m
-  24.90 m²
-  7.90 x 3.20 m
-  1.50 m
-  2.40 m³
-  4
- 

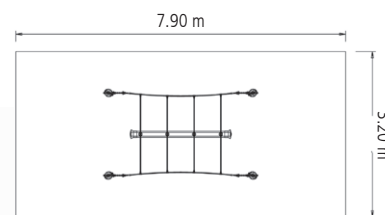
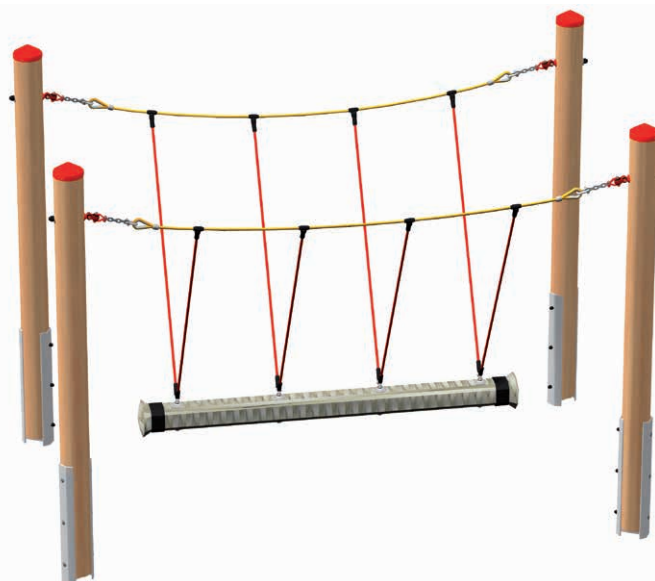











Cyclops Swinger, 4-seater, single

Art. No. 4585-MD4



For symbol explanation see folding card at the back

Picture shows double version with 3 seats each,
Picture shows single version with 4 seats.
3 or 5 seats version also available upon request.

-  2.55 m
-  5.00 x 2.15 m
-  26.50 m²
-  8.85 x 3.20 m
-  1.50 m
-  1.00 m³
-  6
- 

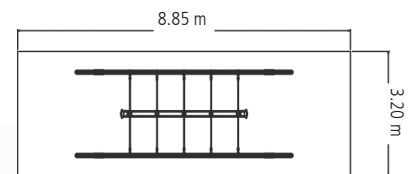









Hydra Swinger, 4-seater, double

Art. No. 4585-MDD4



For symbol explanation see folding card at the back

-  2.55 m
-  5.00 x 4.15 m
-  45.60 m²
-  8.85 x 5.20 m
-  1.50 m
-  1.50 m³
-  12
- 

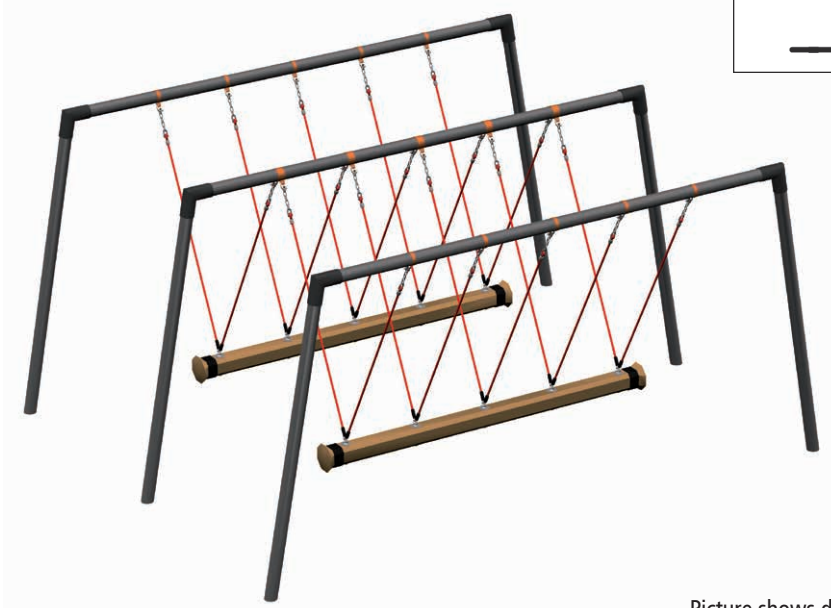
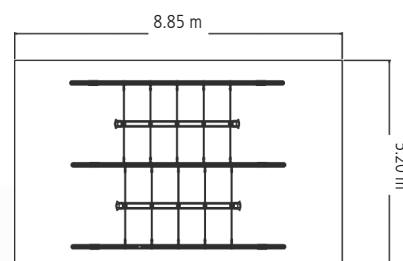

Picture shows double version, each with 4 seats.
Further designs with 3 or 5 seats on request!



FOR JOY!



PARCOURS

Simply combine to suit

Highly variable, easy to install, easy to maintain and suitable for children aged from 2-14 years. Create your own playground according to your individual needs and space. Depending on age group and requirements, you can choose between different post heights, rubber mats, hanging ropes, wobbly beams, climbing nets and much more. Each parcours is unique and adaptable to suit your specific environment.

The nets are made of Hercules rope; with proven HUCK quality. Basically, all parcours elements (including large playground equipment) can be combined with each other. Give us your desired combination, and we will happily advise on suitable design and fit. Lacking in space? No problem, we have the solution.

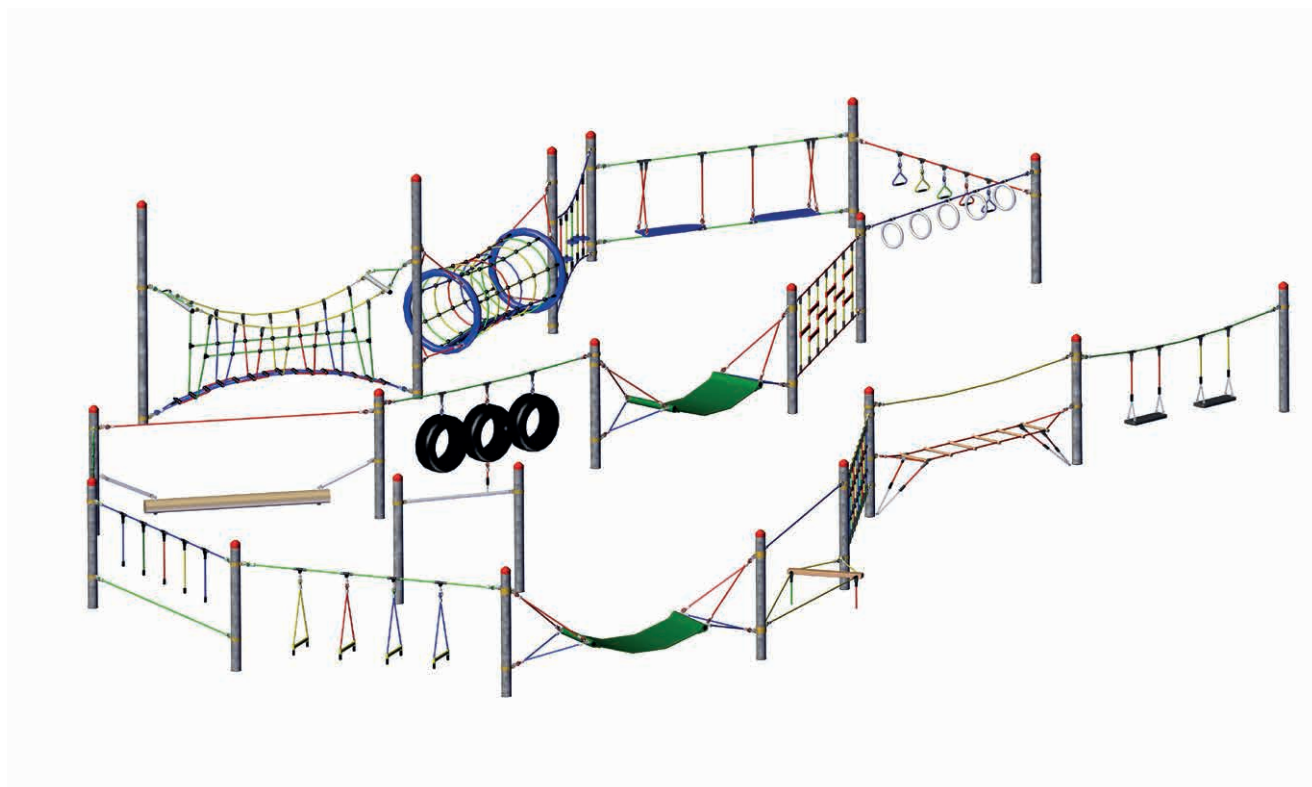



Possible Combinations

All individual elements (on page 110-114) can be combined with one another

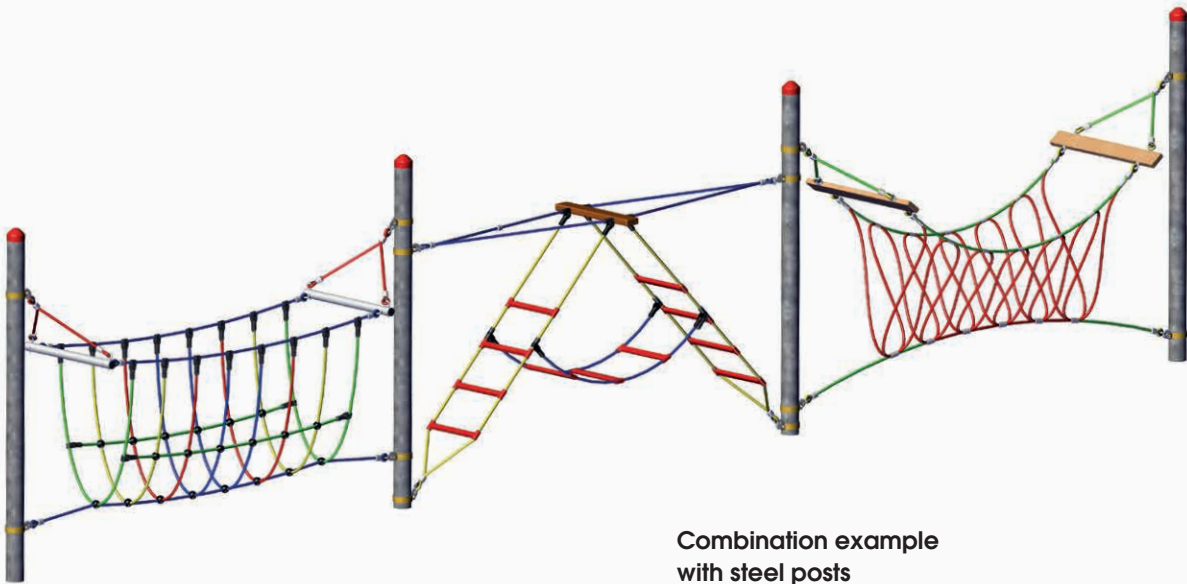

**Combination example
with steel posts**

Bridge "Fun-course"
3-Part Ladder "Fun-course"
Loop Bridge "Fun-course"

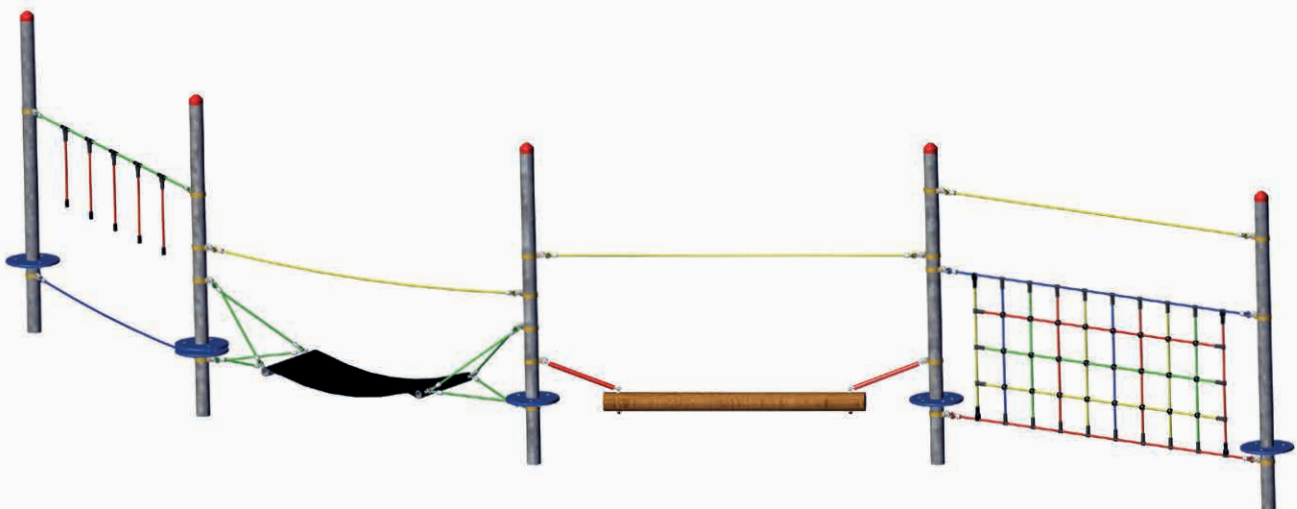

**Combination example
with steel posts**

Hanging Rope "Dillenburg"
Rubber Hammock "Dillenburg"
Wobble Beam "Dillenburg"
Climbing Net "Dillenburg"

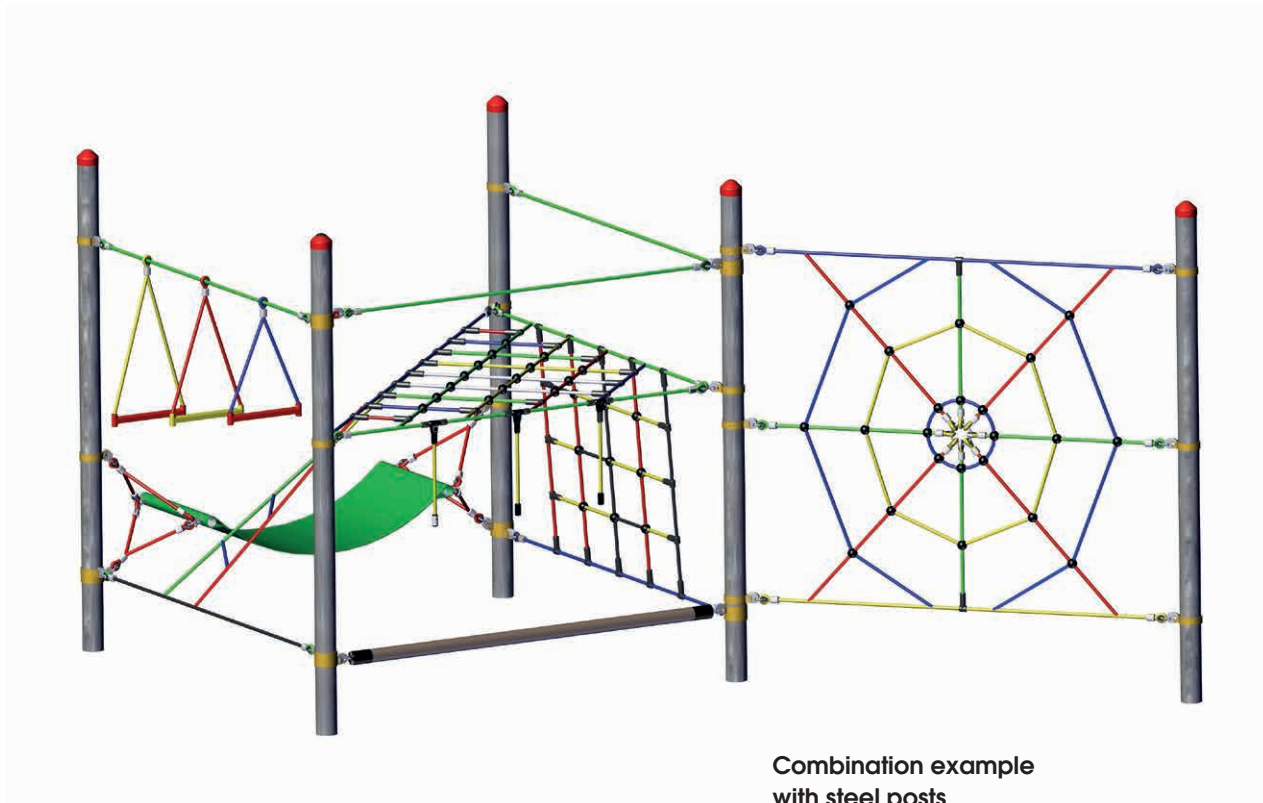

Combination example with steel posts

- | | |
|-----------------|-----------------|
| Vario-Element 1 | Vario-Element 4 |
| Vario-Element 2 | Vario-Element 8 |
| Vario-Element 3 | |

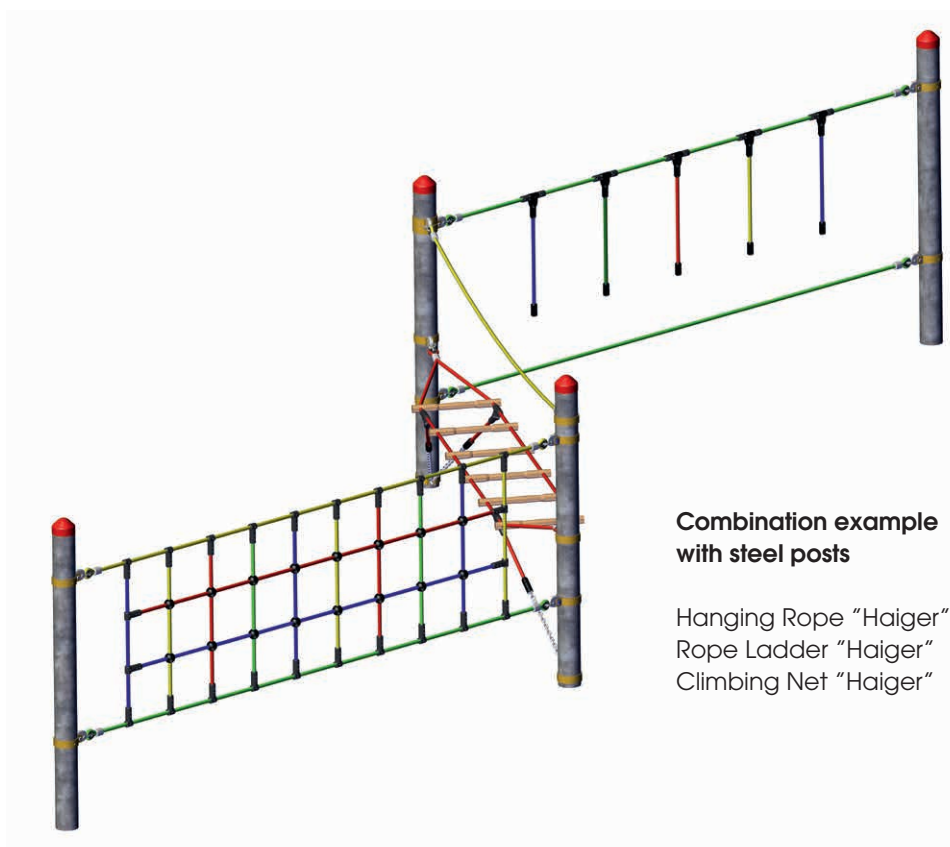

Combination example with steel posts

- Hanging Rope "Haiger"
- Rope Ladder "Haiger"
- Climbing Net "Haiger"



Individual Elements, post spacing of 3.00 m

Without support posts



Swing Seats "Haiger"

Art. No. 4591-1 / Steel
Art. No. 4591-1-R / Robinia

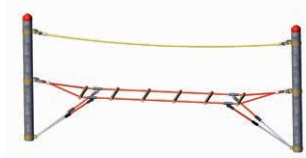

Rope Ladder "Haiger"

Art. No. 4591-2 / Steel
Art. No. 4591-2-R / Robinia

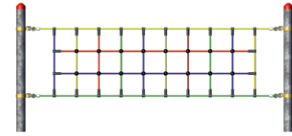

Climbing Net "Haiger"

Art. No. 4591-3 / Steel
Art. No. 4591-3-R / Robinia

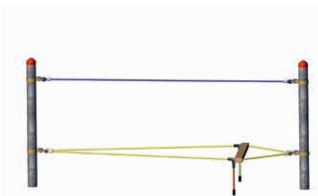

Balancing Rope "Haiger"

Art. No. 4591-4 / Steel
Art. No. 4591-4-R / Robinia



Rubber Hammock "Haiger"

Art. No. 4591-5 / Steel
Art. No. 4591-5-R / Robinia



Rope Ladder Rungs "Haiger"

Art. No. 4591-6 / Steel
Art. No. 4591-6-R / Robinia

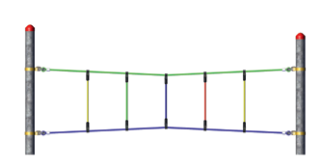

Arc Rope "Haiger"

Art. No. 4591-7 / Steel
Art. No. 4591-7-R / Robinia

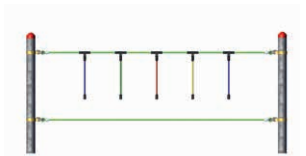

Hanging Rope "Haiger"

Art. No. 4591-8 / Steel
Art. No. 4591-8-R / Robinia

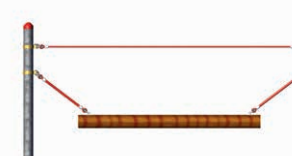

Wobble Beam "Haiger"

Art. No. 4591-9 / Steel
Art. No. 4591-9-R / Robinia



Tyres "Haiger"

Art. No. 4591-10 / Steel
Art. No. 4591-10-R / Robinia



Polyester Hammock "Haiger"

Art. No. 4591-11 / Steel
Art. No. 4591-11-R / Robinia



Climbing Rungs "Haiger"

Art. No. 4591-12 / Steel
Art. No. 4591-12-R / Robinia

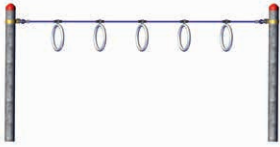

Holding Rings
"Haiger"

Art. No. 4591-13 / Steel
Art. No. 4591-13-R / Robinia



Holding Loops
"Haiger"

Art. No. 4591-14 / Steel
Art. No. 4591-14-R / Robinia

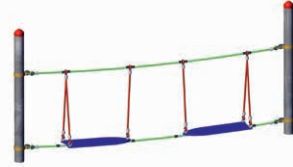

Surfer
"Haiger"

Art. No. 4591-15 / Steel
Art. No. 4591-15-R / Robinia

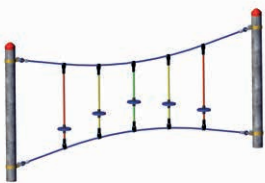

Small Disc
"Haiger"

Art. No. 4960-3 / Steel
Art. No. 4960-3-R / Robinia



Bar, single
"Haiger"

Art. No. 4960-9 / Steel

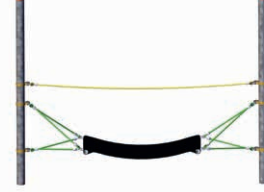

Rubber Hammock
"Dillenburg"

Art. No. 4591-60-5 / Steel
Art. No. 4591-60-5-R / Robinia

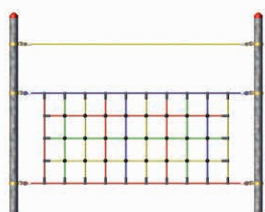

Climbing Net
"Dillenburg"

Art. No. 4591-60-3 / Steel
Art. No. 4591-60-3-R / Robinia

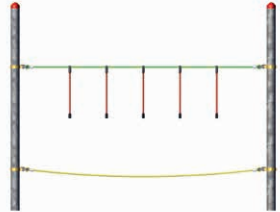

Hanging Rope
"Dillenburg"

Art. No. 4591-60-8 / Steel
Art. No. 4591-60-8-R / Robinia

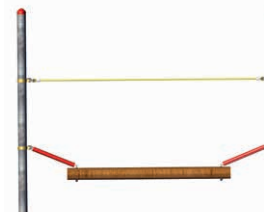

Wobble Beam
"Dillenburg"

Art. No. 4591-60-9 / Steel
Art. No. 4591-60-9-R / Robinia



Individual Elements, post spacing of 2.25 m

Without support posts

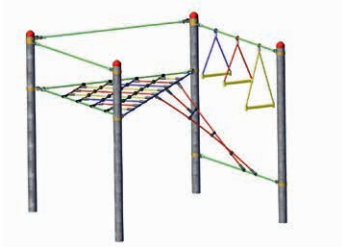

Vario-Element 1

Art. No. 4591-30-1 / Steel
Art. No. 4591-30-1-R / Robinia

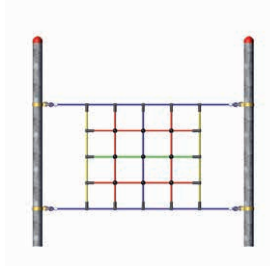

Vario-Element 2

Art. No. 4591-30-2 / Steel
Art. No. 4591-30-2-R / Robinia

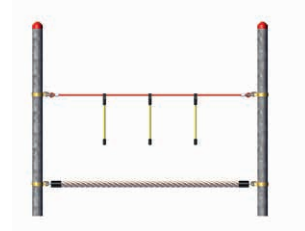

Vario-Element 3

Art. No. 4591-30-3 / Steel
Art. No. 4591-30-3-R / Robinia



Vario-Element 4

Art. No. 4591-30-4 / Steel
Art. No. 4591-30-4-R / Robinia

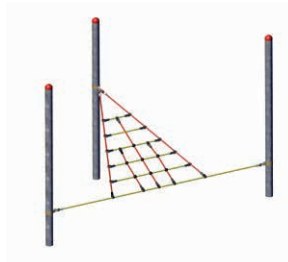

Vario-Element 5

Art. No. 4591-30-5 / Steel
Art. No. 4591-30-5-R / Robinia

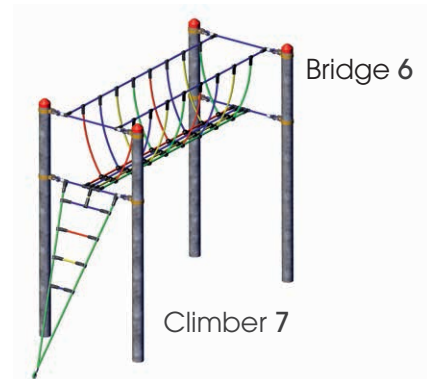

Vario-Element 6 + 7

Bridge 6:
Art. No. 4591-30-6 / Steel
Art. No. 4591-30-6-R / Robinia

Climber 7:
Art. No. 4591-30-7 / Steel
Art. No. 4591-30-7-R / Robinia

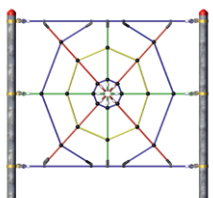

Vario-Element 8

Art. No. 4591-30-8 / Steel
Art. No. 4591-30-8-R / Robinia

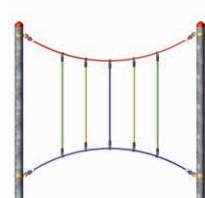

Vario-Element 9

Art. No. 4591-30-9 / Steel
Art. No. 4591-30-9-R / Robinia

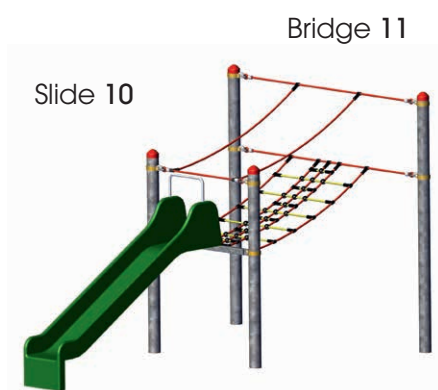

Vario-Element 10 + 11

Slide 10:

Art. No. 4591-30-10 / Steel
Art. No. 4591-30-10-R / Robinia

Bridge 11:

Art. No. 4591-30-11 / Steel
Art. No. 4591-30-11-R / Robinia



Vario-Element 12

Art. No. 4591-30-12 / Steel
Art. No. 4591-30-12-R / Robinia



Vario-Element 13

Art. No. 4591-30-13 / Steel
Art. No. 4591-30-13-R / Robinia



Vario-Element 14

Art. No. 4591-30-14 / Steel
Art. No. 4591-30-14-R / Robinia

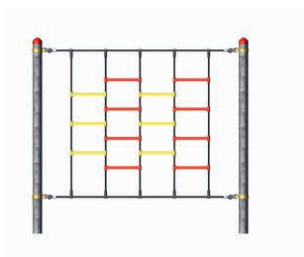

Vario-Element 15

Art. No. 4591-30-15 / Steel
Art. No. 4591-30-15-R / Robinia



Vario-Element 16

Art. No. 4591-30-16 / Steel
Art. No. 4591-30-16-R / Robinia

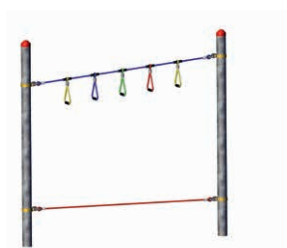

Vario-Element 17

Art. No. 4591-30-17 / Steel
Art. No. 4591-30-17-R / Robinia

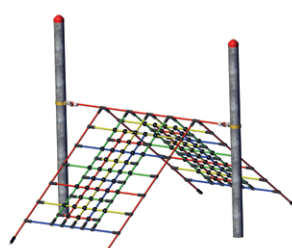

Vario-Element 19

Art. No. 4591-30-19 / Steel
Art. No. 4591-30-19-R / Robinia



Vario-Element 20

Art. No. 4591-30-20 / Steel
Art. No. 4591-30-20-R / Robinia



Individual Elements, post spacing of 3.00 m

Without support posts

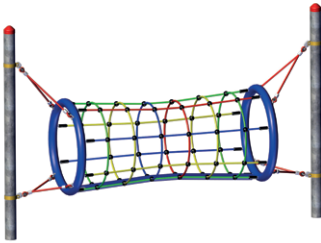

Adventure Tunnel
"Fun course"

Art. No. 4960-1 / Steel
Art. No. 4960-1-R / Robinia

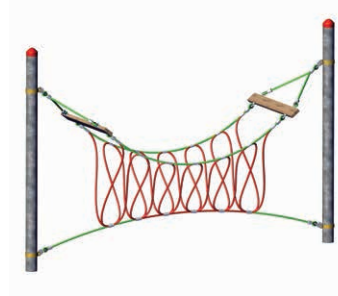

Loop Bridge
"Fun course"

Art. No. 4960-2 / Steel
Art. No. 4960-2-R / Robinia



3-part Ladder
"Fun course"

Art. No. 4960-4 / Steel
Art. No. 4960-4-R / Robinia



Arc Bridge
"Fun course"

Art. No. 4960-5 / Steel
Art. No. 4960-5-R / Robinia

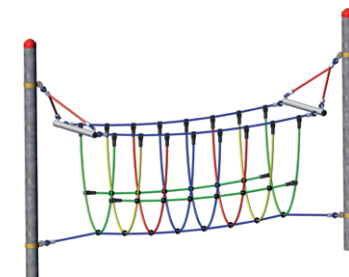

Bridge
"Fun course"

Art. No. 4960-6 / Steel
Art. No. 4960-6-R / Robinia

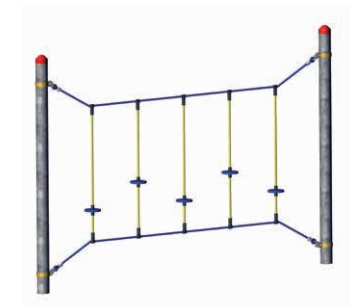

Small Discs
"Fun course"

Art. No. 4960-7 / Steel
Art. No. 4960-7-R / Robinia

Support posts in steel or robinia

Available individually / length of post based on element selected

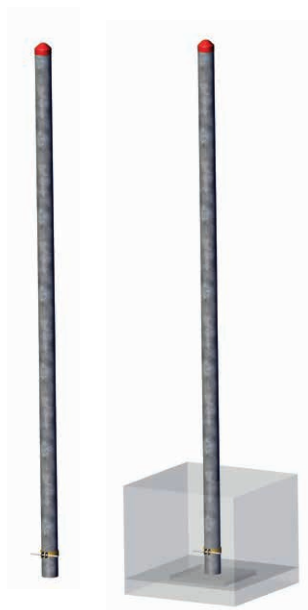

Steel posts

Ø 102 mm
hot-dip galvanised incl. red post cap

🔍 See page 8 for information on posts



Robinia posts

Ø 160 - 200 mm
incl. steel shoes

Length 2.40 m

"Haiger"-Element / Art. No. 4591-0

Length 2.30 m

"Haiger"-Element / Art. No. 4591-0-R

Length 3.00 m

"Fun-Parcours"-Element / Art. No. 4960-0

Length 3.00 m

"Fun-Parcours"-Element / Art. No. 4960-0-R

Length 3.40 m

"Vario" and "Dillenburg"-Elements
Art. No. 4591-30-0

Length 3.40 m

"Vario" and "Dillenburg"-Elements
Art. No. 4591-30-0-R

Foot plate for all steel posts

Art. No. 4591-60-S
Height adjustable



Foot plate for all Robinia posts

Art. No. 4575-S
Height must be specified
when ordering



- ⊕ Steel posts are available Powder-Coated on request
- ⊕ Most RAL colours are available



Plenty of fun with our Parcours Elements

Top: Parcours combination example
Left: Loop bridge "Fun course"
Below: Adventure tunnel "Fun course"

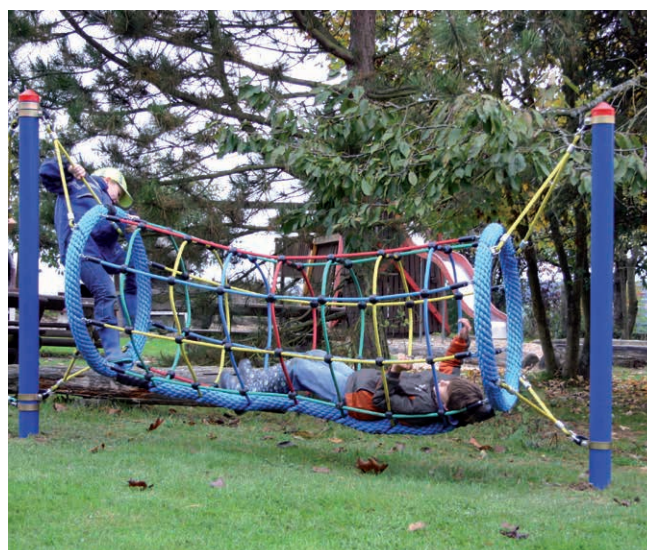



Above: Parcours combination with powder-coated steel posts
Right: Rubber Hammock "Dillenburg"
Below: Vario-Element 12, 4 and 8





GO WILD!



CLIMBING NETS AND BRIDGES

The positive influence of climbing is undisputed. For children this activity could result in their motor skills being trained, improved and reinforced. Our nets stimulate children to face these experiences and at the same time still provides for maximum safety.

Creativity knows no bounds thanks to our vast selection: we offer you different colours, lengths and materials so that the bridges, nets, ropes and ladders completely match your wishes and expectations.



High-quality connectors for our Hercules ropes

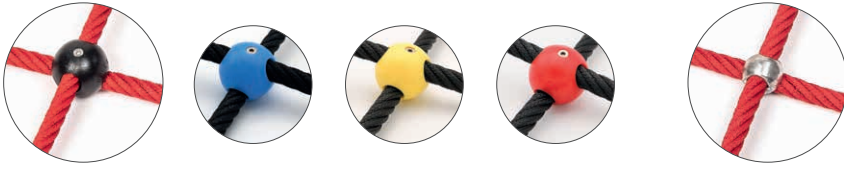

HUCK plastic knot system

In use worldwide for decades, our HUCK plastic knot ball with a diameter of 48 mm connects a wide variety of nets and ropes. Whether simple climbing nets or large net landscapes in various shapes and sizes - the HUCK knot ball offers a reliable and durable connection (also available in 2 parts for repair purposes)

- ✔ Round form without corners and edges for pleasant tactile feel
- ✔ Can be easily replaced
- ✔ Colour options in beige and black
And new additions in blue, yellow, red

HUCK aluminium knot system

For special applications, HUCK also offers aluminum knot balls with a diameter of 28 mm (for HUCK Hercules rope Ø 18)

- ✔ High transmission of force between ropes
- ✔ Round form without corners and edges for pleasant tactile feel



HUCK Stainless-steel clips

These connectors, which are suitable for horizontal nets, are particularly characterized by their high-quality material and clear design.

- ✔ high-quality design, matches a wide variety of rope colors
- ✔ comfortable to lie down and relax
- ✔ made of stainless steel V2A



HUCK Cross-stitch connector

Executed in a cross-stitch design for Hercules ropes, we use this knot connector at the customer's request to put the rope in the foreground. Particularly popular for horizontal nets – e.g. hammocks.

- ✔ Colour options: blue, black, red, beige
- ✔ pleasant for laying on and relaxing
- ✔ rope in the foreground





Climbing Nets / PP-Rope

PP-Climbing Nets with braided knots

Art. No.	Description	Mesh size in mm
4116-110	PP, Ø 16 mm	110
4116-250	PP, Ø 16 mm	250
4116-300	PP, Ø 16 mm	300
4116-400	PP, Ø 16 mm	400
4116-500	PP, Ø 16 mm	500
4120-250	PP, Ø 20 mm	250
4120-300	PP, Ø 20 mm	300
4120-400	PP, Ø 20 mm	400
4120-500	PP, Ø 20 mm	500
4125-250	PP, Ø 25 mm	250
4125-300	PP, Ø 25 mm	300



⊕ Low-cost Alternative

16 mm in diameter but no steel core, our PP rope is more reasonable than the Hercules rope and is brilliantly perfect for the indoor area.

⊕ Flexible Connector

Braided knots, not only look great, but also make the rope flexible.

⊕ Colour options

The 4-shaft rope made from PP multi-strand is available in the following colours: black, beige, orange, green and blue.





Climbing Nets made from Hercules rope

Hercules-Climbing Nets

made from Ø 16 mm Hercules rope, six-strand, with knot ball system

Art. No.	Description	Mesh size in mm
4316-125	Hercules, Ø 16 mm	125
4316-250	Hercules, Ø 16 mm	250
4316-300	Hercules, Ø 16 mm	300
4316-350	Hercules, Ø 16 mm	350
4316-400	Hercules, Ø 16 mm	400
4316-500	Hercules, Ø 16 mm	500



Hercules-Climbing Nets

made from Ø 18 mm Hercules rope, six-strand, with aluminium knot ball system

Art. No.	Description	Mesh size in mm
4618-120	Hercules, Ø 18 mm	120
4618-250	Hercules, Ø 18 mm	250
4618-300	Hercules, Ø 18 mm	300
4618-350	Hercules, Ø 18 mm	350
4618-400	Hercules, Ø 18 mm	400
4618-500	Hercules, Ø 18 mm	500

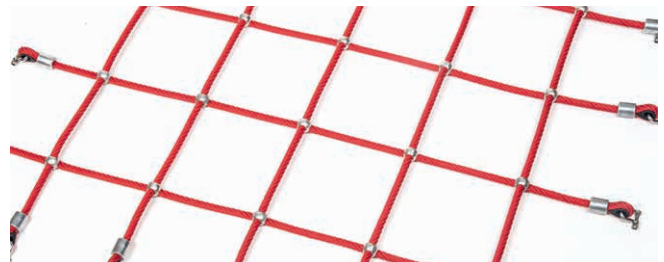

Hercules-Climbing Nets

made from Ø 16 mm Hercules rope, six stranded, with stainless steel clips

Art. No.	Description	Mesh size in mm
4516-120	Hercules, Ø 16 mm	120
4516-250	Hercules, Ø 16 mm	250
4516-300	Hercules, Ø 16 mm	300
4516-350	Hercules, Ø 16 mm	350
4516-400	Hercules, Ø 16 mm	400
4516-500	Hercules, Ø 16 mm	500

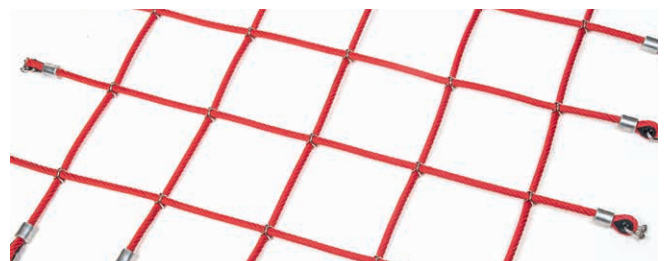

Hercules-Climbing Nets

made from Ø 16 mm Hercules rope, four-stranded, with cross-stitch connection

Art. No.	Description	Mesh size in mm
4416-120	Hercules, Ø 16 mm	120
4416-250	Hercules, Ø 16 mm	250
4416-300	Hercules, Ø 16 mm	300
4416-400	Hercules, Ø 16 mm	400
4416-500	Hercules, Ø 16 mm	500

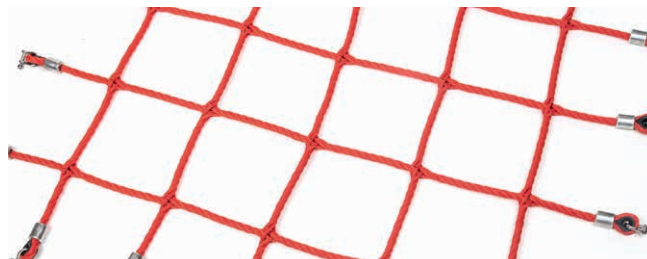

IMPORTANT!

Please specify when ordering:

- 1) lightweight frame dimensions
- 2) intended attachment side
- 3) fastening devices
- 4) Length of fastener required (thread lengths)
- 5) Rope colour:



black 06
 fluorescent-orange- 03F
 hemp coloured 08
 light grey 66
 red 07
 fuchsia 71
 blue 04
 yellow 05
 green 01
 turquoise 11
 rust 03
 Nets: multi-coloured 09

Smaller size supplements for climbing nets

under 1 m² + 50 %, under 2 m² + 25 %



Exemplary mounting options for climbing nets, climbing ropes, bridges, etc.

We have developed many, well-thought out and practical solutions, facilitating the attachment of our ropes to the most varied of elements. You will find a small selection below; please do not hesitate to contact our contact persons for further information on special solutions.

Please note that these elements are designed exclusively for use with our Hercules rope. Unfortunately, it is not possible to buy single elements.

Net edging connectors + Now in new slim design



Plastic T-connectors



Plastic T joint

Attachment to posts and beams

Bolt lengths freely selectable / bolts in stainless steel as standard



Eyebolt stainless steel
Art. No. 455B
M8/M10/M12 with threaded end



Threaded bolt, stainless steel
Art. No. 454V
M8/M10/M12



Threaded bolt, stainless steel
Art. No. 454
M10/M12 with threaded end



Eyebolt stainless steel
Art. No. 455-M10
Art. No. 455-M12



Rope Loop
Art. No. 464
Inner diameter freely selectable



Thimble stainless steel
Art. No. 457VA
inner diameter 35 mm



Plastic round thimble
Art. No. 457R
Black, inner diameter 35 mm



Steel ring, galvanized
Art. No. 453
M8 x 40 mm, M10 x 50 mm,
M10 x 60 mm



Chain 6 mm
Art. No. 461V
Galvanized, (short links)
direct crimped



Chain 6 mm
Art. No. 461
Galvanized, (short links)
Incl. plastic adaptor



Chain shackle, stainless steel
Art. No. 440-30
For 6 mm or 8 mm chain,
(short links)



Shackle stainless steel
Art. No. 440-8G
M8 (cambered), crimped



Further stainless steel fixings and connectors



Chain adapter M12, stainless steel
 Art. No. 461-6
 including threaded bolts,
 for connection with 6 mm chain



Chain adapter M16, stainless steel
 Art. No. 461-8
 including threaded bolts,
 for connection with 8 mm chain



Chain shackle M6, stainless steel
 Art. No. 440-6-3
 3 split connector for 6 mm chain



Chain shackle M6 stainless steel
 Art. No. 440-6-4
 4 split connector for 6mm chain



Bearing connector, stainless steel
 Art. No. 430
 For shackle M8 oder M10
 Also 2 or 3 eyelet shackle
 M16 or M12 threaded bolt



**Bearing connector, stainless steel
 with threaded bolt**
 Art. No. 443
 For shackle M8 or M10
 Also 2 or 3 eyelet shackle on M12
 threaded bolt (inner thread)



Sleeve nut M12 stainless steel
 Art. No. 433
 with torx drive and inner thread M12





Thimble chain sprocket stainless steel

Art. No. 4603-20

swivel with with wear-resistant bronze bearing for maximum torc load of 6 mm or 8 mm chain on Hercules rope Ø 16 mm



Thimble swivel, stainless steel

Art. No. 4603-10

swivel ring with wear-resistant bronze bearing from VA anchor or bearing

Art. No. 4602 on Hercules rope Ø 16 mm



2-eyelet shackle, stainless steel

incl. cross bolt M10

Art. No. 440-10

without bearing, ideal for corner formation with horizontal nets, for Hercules rope Ø 16 mm or Ø 18 mm, also available as a 3-eyelet shackle, incl. cross bolt M8



3-eyelet shackle made of stainless steel

incl. cross bolt M10

Art. No. 440-20

ideal for forming corners in horizontal nets, for Hercules rope Ø 16 mm or 18 mm on chain 6 mm, 8 mm or VA anchor, incl. cross bolt M8



➕ Further fixings available on our website. Allow us to help you!





Climbing ropes

Please observe the requirements of DIN EN 1176-1 Para. 4.2.12 when using climbing ropes: For ropes with an attachment on one side (Length up to 2.00 m) the distance to the next fixed piece of equipment must be 60 cm. For rope lengths between 2.00m and 4.00 m this distance can be increased to 1.00 m The lengths specified are standard lengths, other lengths can be requested.



Art. No. 480



Art. No. 481



Art. No. 38250

PP-Climbing rope

Art. No.	Product description	Diameter	Rope colour	Length	Top attachment	Bottom attachment
480	PP-Climbing rope	24 mm	orange, blue, hemp coloured	2.00 m	Thimble and ring 10 x 50 mm, galvanized	1 x knot + plastic end cap
481	PP-Climbing rope with knots	24 mm	orange, blue, hemp coloured	2.00 m	Thimble and ring 10 x 50 mm, galvanized	Plastic-end cap
38250	PP-Climbing rope	33 mm	hemp coloured	2.50 m	Galvanized rope holder	Plastic sleeve



Art. No. 479 | 482



Art. No. 483



Art. No. 484

Hercules Climbing rope

Art. No.	Product description	Diameter	Rope colour	Length	Top attachment	Bottom attachment
479	Hercules Climbing rope	16 mm	green, orange, blue, yellow, fluorescent orange, black, grey, red, hemp coloured, rust	2.00 m	Thimble and ring 10 x 50 mm, galvanized	Plastic-end cap
482	Hercules Climbing rope	18 mm	green, blue, yellow, black, red, hemp coloured	2.00 m	Thimble and ring 10 x 50 mm, galvanized	Plastic-end cap
483	Hercules Climbing rope with climbing aid*	18 mm	green, blue, yellow, black, red, hemp coloured	2.00 m	Thimble and ring 10 x 50 mm, galvanized	Plastic-end cap
484	Hercules Climbing rope	25 mm	blue, yellow, red, hemp coloured	2.00 m	Thimble and ring 10 x 50 mm, galvanized	Plastic-end cap

*Colours of climbing aids: yellow, red, black or hemp coloured

Double-sided connections for climbing ropes



Supplement for bottom attachment
Art. No. 4825



Example (without ground anchor screw):
6 mm galvanized chain, length approx. 40 cm (in the ground) or ring bolts on both rope ends or other fastening options (pages 124-126).



Ground anchor (screwable)
Art. No. 410

Steel (Ø ca. 10 mm), hot-dip galvanized
Length approx. 40 cm



Loops/Rings



Art. No. 403



Art. No. 404



Art. No. 404K



Art. No. 404-1



Art. No. 474



Art. No. 4741

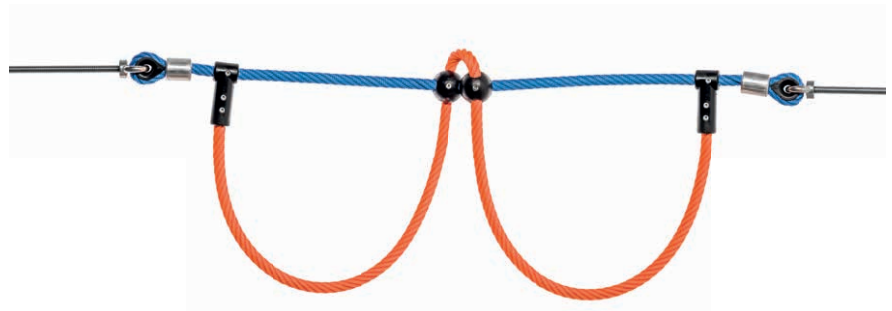

Art. No. 489-10

Art. No.	Product description	Rope colours	Design
403	Roman ring		Without rope and chain
404	Roman ring with Hercules rope	green, orange, fluorescent orange, blue, yellow, black, grey, red, hemp coloured, turquoise, fuchsia	20 cm Hercules rope and rings screw M12 x 200 mm
404K	Roman ring with Hercules rope & thimble swivel	green, orange, fluorescent orange, blue, yellow, black, grey, red, hemp coloured, turquoise, fuchsia	20 cm Hercules rope and Thimble swivel + VA bearing adapter M12 x 200mm
404-1	Roman ring with chain		20 cm chain 6 mm vz. and Eyebolt M12 x 200mm
474	Polyester gym ring (Outside) Ø 290 mm		Without rope and chain
4741	Polyester gym ring 28 x 240 mm with 16 mm Ø – Hercules rope	green, orange, fluorescent orange, blue, yellow, black, grey, red, hemp coloured, turquoise, fuchsia	50 cm Hercules rope and 40 cm 6 mm vz chain
489-10	Garland rope with 16 mm Ø – Hercules rope	green, orange, fluorescent orange, blue, yellow, black, grey, red, hemp coloured, turquoise, fuchsia	both rope ends with Eyebolt M12 x 200 mm Stand length 3.00 m

On request, the versions can be selected individually (e.g. lengths, fixtures).





Ladders

Our rope ladders are designed and developed to be used on playground area, the maximal load per ladder is 150 kg. They are not to be used as a rescue ladder or in the industrial area with the corresponding extensions. The distance between the rungs is 30 cm, the ladder width is approx.

40 cm. The recommended ground clearance to the lowest rung is 40 cm. The ladder length ordered is always measured from top suspension point to the lowest rung.



Art. No. 40



Art. No. 42



Art. No. 44

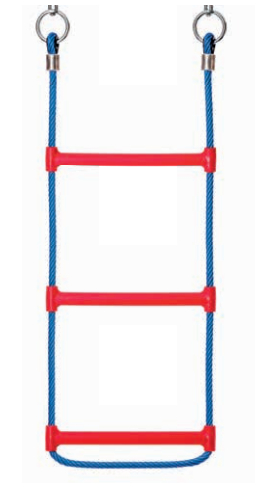

Art. No. 44-10

Art. No.	Rungs	Rope suspension	Rope colours	Design
40	Acacia wood	PP-Multi strand rope, Ø 16 mm	Orange, blue, hemp coloured, black, green (new)	Both top rope ends with thimble and ring 10 x 50 mm, galvanized
42	Aluminium	Hercules rope, Ø 16 mm	green, orange, fluorescent orange, blue, yellow, black, grey, red, hemp coloured, turquoise, fuchsia	Both top rope ends with thimble and ring 10 x 50 mm, galvanized
44	Acacia wood	Hercules rope, Ø 16 mm	green, orange, fluorescent orange, blue, yellow, black, grey, red, hemp coloured, turquoise, fuchsia	Both top rope ends with thimble and ring 10 x 50 mm, galvanized
44-10	Plastic	Hercules rope, Ø 16 mm	green, orange, fluorescent orange, blue, yellow, black, grey, red, hemp coloured, turquoise, fuchsia	Both top rope ends with thimble and ring 10 x 50 mm, galvanized

Possible Ladder fixings



1 point fixing



2 point fixing

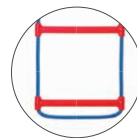

Without fixing (standard)

Supplement for bottom attachment
Art. No. 4826

Examples (without ground anchor screw)
6 mm galvanized chain, length approx. 40 cm (in the ground)
or 1x or 2x ground anchor chain
or other mounting options (page 124-126).



Ground anchor (screwable)
Art. No. 410

Steel (Ø ca. 10 mm), hot-dip galvanized
Length approx. 40 cm

Net bridge

in V-Form, per running m.

Art. No. 4957-300

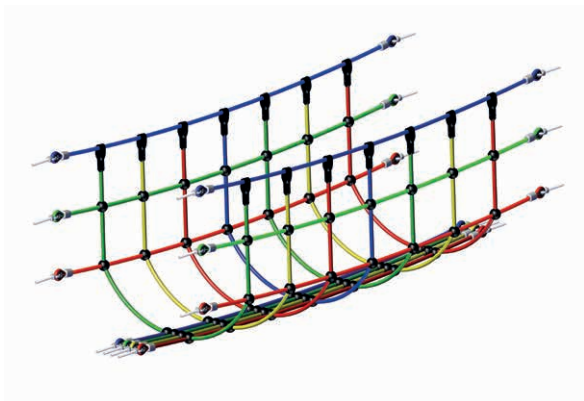

Net handrails

For wooden or rubber walkway,
per running metre

Art. No. 4910-300 Mesh size 30 x 25 cm

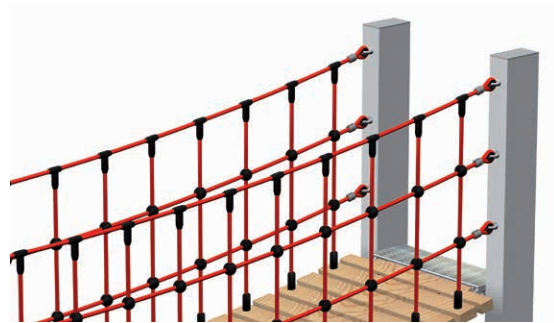

Simple Net Bridge

per running metre

Art. No. 4959-250

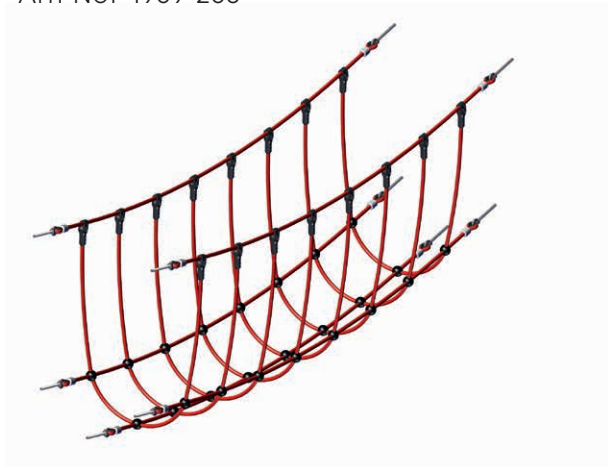

Net bridge

With additional wooden rungs,
per running metre

Art. No. 4952

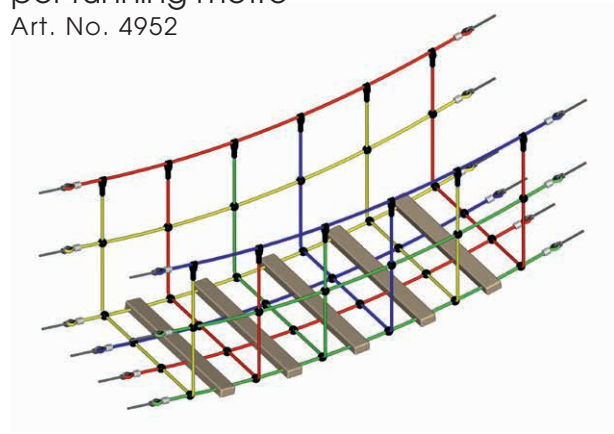

The illustrations are examples of standard bridges. Individual customization is possible.

Art. No.	Product description	Walkway	MW Walkway	Handrail height	MW handrail	Handrail width	Nominal width Footbridge	Attachments
4957-300	Net bridge in V-Form	4 x Hercules rope	3 x 5 cm	85 cm	30 x 30 cm	80 cm	18 cm	Eyebolt M12, Stainless steel
4910-300	Net handrails, both sides			85 cm	25 x 30 cm			Eyebolt M12, Stainless steel
4959-250	Simple Net Bridge	Hercules mesh	30 x 30 cm	80 cm	30 x 80 cm	60 cm	60 cm	Eyebolt M12, Stainless steel
4952	Net bridge with wooden rungs	Hercules – mesh and wooden rungs	27 x 30 cm	80 cm	40 x 60 cm	80 cm	80 cm	Eyebolt M12, Stainless steel

Standard items available up to 5.00 m in length, other lengths on request

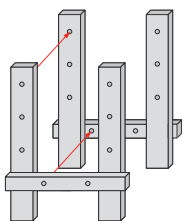

Outer cross beams
(underfoot material longer
than handrail rope)

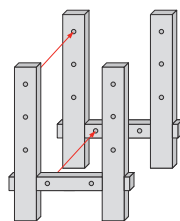

flush cross beams
(all ropes in equal lengths)

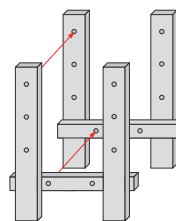

Inside cross beams
(underfoot material shorter
than handrail rope)

When placing an order please give us the following details:

- clear opening between existing frames (Bridge length)
- dimension between axes/centre to centre of posts (Bridge width)
- desired bolt lengths of eyebolts
- Position of crossbeams to attach the underfoot material to
- Height variation between cross beams

Wooden Walkway

per running metre

Art. No. 4930-005-050 Nominal width 50 cm
 Art. No. 4930-005-075 Nominal width 75 cm
 Art. No. 4930-005-100 Nominal width 100 cm



Rubber Walkway

per running metre

Art. No. 4950
 Nominal width 55 cm, Length max. 3.00 m

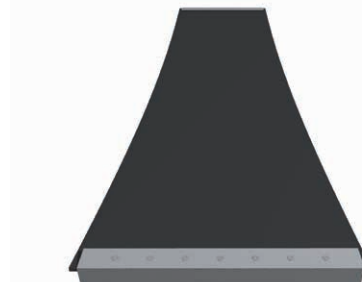

Jungle Bridge

per running metre

Art. No. 4954-300
 with PP rope, beige, approx 90/90 mm

Art. No. 4956-300
 With PP running rope, beige, approx 160/160 mm,
 length up to 5.00 m
 New colours available: blue, green, black

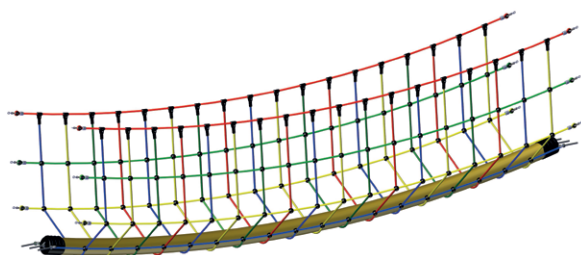

PP-Walkway rope

per running metre

Art. No. 4325-0090-08 walkway: 90/90 mm
 Possible colours: beige

Art. No. 4325-0160-08 walkway: 160/160 mm,
 Possible colours: beige

(no colour choice available with either product)



All running ropes with comfortable
 square cross section

“plus” fixings at both end of
 each running rope

Art. No. 495 e.g. Ring screw

Art. No.	Product description	Walkway	Handrail height	MW Handrail	Handrail width	Nominal walkway	Attachments
4930-005-050	Wooden Walkway, 50 cm Nominal width	Larch rungs, 45 x 95 mm				50 cm	Eyebolt M12, Stainless steel
4930-005-075	Wooden Walkway, 75 cm Nominal width	Larch rungs, 45 x 95 mm				75 cm	Eyebolt M12, Stainless steel
4930-005-100	Wooden Walkway, 100 cm Nominal width	Larch rungs, 45 x 95 mm				100 cm	Eyebolt M12, Stainless steel
4950	Rubber Walkway 55 cm Nominal width	Closed rubber base				55 cm	Extended ends
4954-300	Jungle Bridge	90/90 mm PP-Walkway rope	85 cm	30x30 cm	85 cm	9 cm	Eyebolt M12 / M16, Stainless steel
4956-300	Jungle Bridge	160/160 mm PP-Walkway rope	85 cm	30x30 cm	85 cm	16 cm	Eyebolt M12 / M16, Stainless steel
4325-0090-08 + 495	PP-Walkway rope	90/90 mm				9 cm	Eyebolt M12/M16, Stainless steel (Art. No. 495)
4325-0160-08 + 495	PP-Walkway rope	160/160 mm				16 cm	Eyebolt M12/M16, Stainless steel (Art. No. 495)

Standard items available up to 5.00 m in length, other lengths on request



HUCK Net Tunnel

Our net tunnels come in the most varied of forms and designs: round, square or triangular as add-ons to existing rope structures or as complete special structure in overlengths.

Hercules mesh is used for the covering, larch wooden rungs for the walkway or a rubber band or PP walking ropes available in different colours. Ring us and let us advise you!

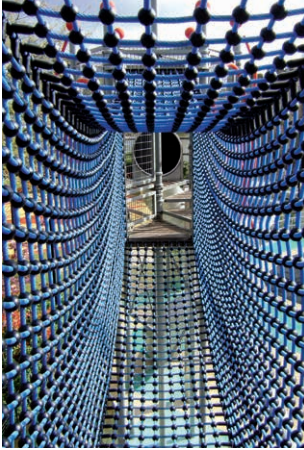

Net tunnel, square, underfoot material Hercules mesh



Net tunnel, round, underfoot material made from Hercules mesh incl. rope-wrapped steel ring

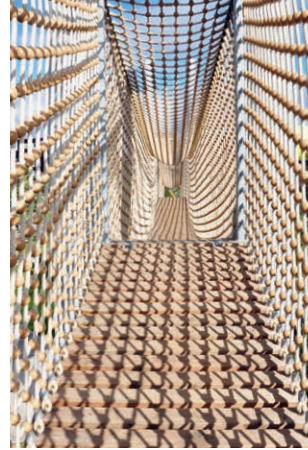

Net tunnel, square, underfoot material made from larch wooden rungs



Net tunnel, triangular, walkway made from PP walking rope

Art. No.	Product description	Walkway	MW walkway	Width	MW Handrail	Height	Attachments
4970	Net Tunnel	Hercules mesh	125 x 125 mm	75 cm	30 x 30 cm	90 cm	Eyebolt M12, Stainless steel
4971	Net Tunnel	Hercules mesh	125 x 125 mm	75 cm	30 x 30 cm	120 cm	Eyebolt M12, Stainless steel
4972	Net Tunnel	Hercules mesh	125 x 125 mm	90 cm	30 x 30 cm	90 cm	Eyebolt M12, Stainless steel
4973	Net Tunnel	Hercules mesh	125 x 125 mm	90 cm	30 x 30 cm	120 cm	Eyebolt M12, Stainless steel

Standard items available up to 5.00 m, other lengths on request



HUCK climbing chimney

Our climbing chimneys are also available in the most varied of forms and designs. Round and square, complete with small mesh size, with rope-wrapped ring for stabilisation and so on. Let us design, develop

and produce your individual climbing chimney. Give us a call and let us advise you!





Net bridges and net tunnels made to order

We deliver the individual bridges/tunnels in the appropriate lengths with access components, foundation or reinforcement designs and assembly instructions. We can include assembly if you so wish!

We fit the net bridges with a variety of underfoot materials and connection components.

The length of the bridge is based on the gap you want it to span, plus the required distance from the water's edge to the access point (approx. 1.50 m). Individual connection and construction parts are either decided by according to the bridge/tunnel type or are adapted to existing suspension builds following in-depth discussion with you.

When you order, please refer to the measurements given in the sketch where possible (a to f). With the help of this information we build a bridge/tunnel that conforms to EN 1176 (playground area; max. feet height 3.00 m with appropriate fall protection) or DIN 1055/1072 for public constructions.

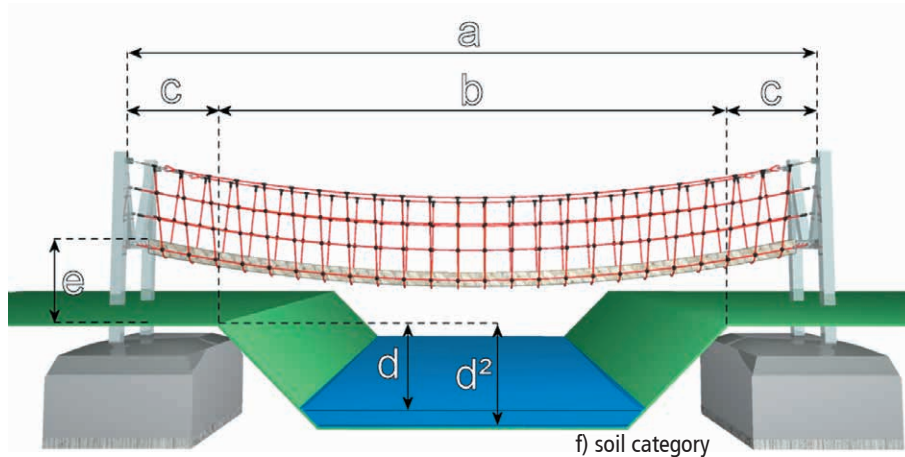

Details required for your order:

- a) clear measurement between the frame or the tower builds (if it exists already)
- b) measurement between any existing embankment edges
- c) measurement between the embankment edge and any existing frames
- d) measurement from the top edge of the play level to any existing water surface
- d²) measurement from the top of the play level to the lowest point on the ground
- e) preferred or existing access height
- f) soil category number (if known)

Installed HUCK – Bridges/tunnel complete solutions



Wooden walkway bridge, Length 54 m



Wooden walkway tunnel, Length 40 m



Net tunnel with suspended walkway rungs, Length 8 m



Wooden walkway bridge, Length 40 m



Jungle bridge in V-Form, Length 20 m



Net tunnel in V-Form (Swimming pool area), Length 21 m



**SWING
AROUND!**



SWINGS

The classical among the swings is without a doubt the Original HUCK Bird's Nest which has stood testimony to safe play for almost thirty years. HUCK swings are suitable for all age groups and can be combined in a multitude of ways, providing big and small with pure enjoyment during play. In addition, we offer many models for people with disabilities, because inclusion in nurseries, schools and on playgrounds is a matter of the heart for us and shall be stipulated in new planning by the legislator.

PRODUCT-HIGHLIGHTS



Swing Frame, douglas fir
| 138 |



Original HUCK Bird's Nest
| 144 |



Hammock made from Hercules rope
| 153 |



Swing Frame "Twin", douglas fir









Art. No. 4577-3-250, without fixings or attachments



For symbol explanation see folding card at the back

Our Original HUCK Bird's Nest can be found on Page 144!

Suspension height: 2.50 m

-  2.75 m
-  7.00 x 3.50 m
-  33.00 m²
-  8.00 x 5.30 m
-  1.45 m (swing seat)
-  1.55 m (Bird's Nest)
-  3.00 m³
-  6
- 



Please note!
The space required for foundations (assembly space) is bigger than the minimum space requirement for the equipment.

Suitable swings parts can be found from page 146 onwards!

- Combination examples:
- Bird's Nest + Bird's Nest
- Bird's Nest + rocking chair
- Bird's Nest + 2x swing seat

Many other combinations possible

Arch Swing to set in concrete









Art. No. 4580-4B, incl. fixings, without attachments



For symbol explanation see folding card at the back

Our Original HUCK Bird's Nest can be found on Page 144!

Suspension height: 2.50 m

-  3.10 m
-  Ø 1.25 m
-  18.45 m²
-  1.25 x 3.95 m
-  1.50 m
-  2.25 m³
-  4
- 



On request, the Arc swing can be painted or powder coated for an additional cost

Please note!
The space required for foundations (assembly space) is bigger than the minimum space requirement for the equipment.



Swing Frame douglas fir

Art. No. 4577-1-200 Suspension height 2.00 m, without attachments and bearings









Art. No. 4577-1-250 Suspension height 2.50 m, without attachments and bearings











For symbol explanation see folding card at the back

Our Original HUCK Bird's Nest can be found on Page 144!

Suspension height: 2.00 m

-  2.25 m
-  4.15 x 2.60 m
-  18.45 m²
-  6.75 x 2.50 m
-  1.20 m (single seat)
-  1.30 m (Bird's Nest)
-  2.00 m³
-  4
- 

Suspension height: 2.50 m

-  2.75 m
-  4.15 x 3.00 m
-  18.90 m²
-  7.60 x 2.50 m
-  1.45 m (single seat)
-  1.55 m (Bird's Nest)
-  2.00 m³
-  4
- 

Please note!

The space required for foundations (assembly space) is bigger than the minimum space requirement for the equipment.



Swing Frame douglas fir, long

Art. No. 4577-2-200 Suspension height: 2.00 m, without attachments and bearings



Art. No. 4577-2-250 Suspension height: 2.50 m, without attachments and bearings



For symbol explanation see folding card at the back

Suitable attachments can be found on Page 146!

Suspension height: 2.00 m

-  2.25 m
-  7.15 x 2.60 m
-  41.00 m²
-  9.05 x 7.20 m
(varies depending on attachment)
-  1.20 m (single seat)
1.30 m (Bird's Nest)
-  2.00 m³
-  8
- 

Suspension height: 2.50 m

-  2.75 m
-  7.15 x 3.00 m
-  44.00 m²
-  9.05 x 8.00 m
(varies depending on attachment)
-  1.45 m (single seat)
1.55 m (Bird's Nest)
-  2.00 m³
-  8
- 

Please note!

The space required for foundations (assembly space) is bigger than the minimum space requirement for the equipment.











Swing Frame "Junior"

Art. No. 4580-3-250, without attachments and bearings



For symbol explanation see folding card at the back

Suspension height: 2.50 m

-  2.75 m
-  3.20 x 3.85 m
-  19.00 m²
-  7.60 x 2.50 m
-  1.45 m (Single seat)
-  1.55 m (Bird's Nest)
-  1.30 m³
-  4
- 

Please note!

The space required for foundations (assembly space) is bigger than the minimum space requirement for the equipment.

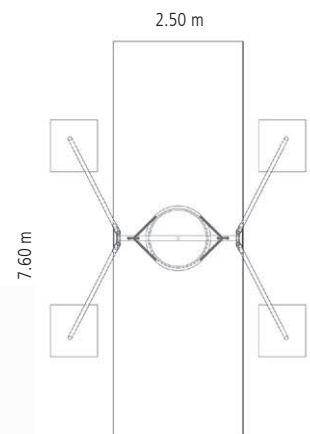

Our Original HUCK Bird's Nest and suitable Attachments can be found on Page 146!

Easy-Swing "Honeycomb Nest"









Art. No. 4591-50-3



Photo shows Mini Bird's Nest as attachment

For symbol explanation see folding card at the back

Suspension height: Can be easily adjusted, 1.40 - 2.00 m
Sitting area: Ø 1.00 m, Octagonal

-  2.40 m
-  2.50 x 1.00 m
-  15.50 m²
-  6.90 x 2.25 m
-  1.35 m
-  0.80 m³
-  3
- 

Equipment
2 Steel posts (Ø 102 mm),
hot-dip galvanised, length 3.40 m

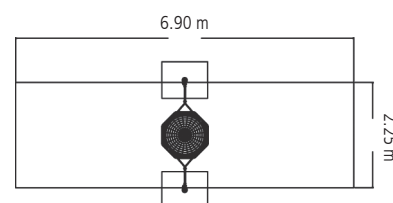

Please note!

The space required for foundations (assembly space) is bigger than the minimum space requirement for the equipment.





Easy-Swing "Swing Bed"







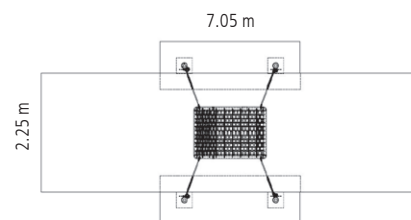

Art. No. 4591-50-9



For symbol explanation see folding card at the back

Suspension height: Can be easily adjusted, max. 2.00 m
Sitting area: 1.20 x 0.90 m



-  2.44 m
-  2.65 x 1.85 m
-  15.60 m²
-  7.05 x 2.25 m
-  1.25 m
-  2.90 m³
-  5
- 
- 

Equipment
4 Steel posts (Ø 102 mm),
hot-dip galvanised, length 3.40 m



Please note!

The space required for foundations (assembly space) is bigger than the minimum space requirement for the equipment.



Easy-Swing "Midi"

Art. No. 4591-50-2

Sitting area (W x H x D): 0.55 m x 0.90 m x 0.60 m



Easy-Swing "Maxi"

Art. No. 4591-50-1

Sitting area (W x H x D): 0.80 m x 1.05 m x 0.80 m



For symbol explanation see folding card at the back

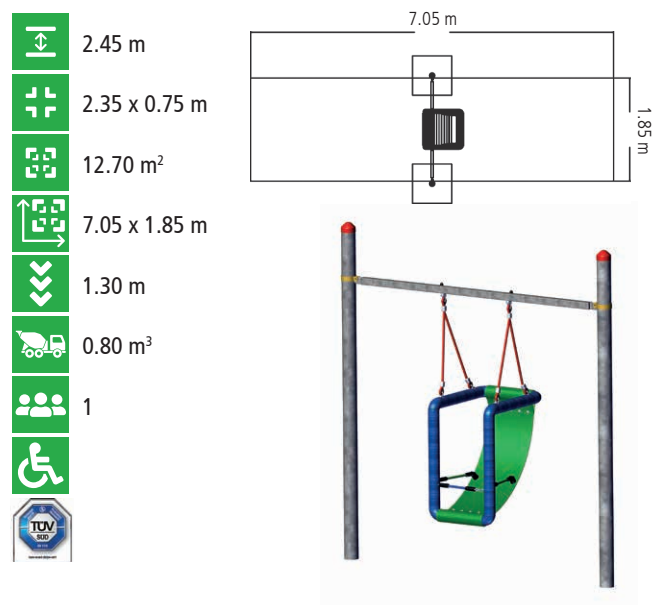

Please note!

The space required for foundations (assembly space) is bigger than the minimum space requirement for the equipment.

Equipment

2 Steel posts (Ø 102 mm), hot-dip galvanised, length 3.40 m, Inc. Posts and suspension bearings

Subject to Technical changes

For symbol explanation see folding card at the back

See table on page 200 for additional information.



Please note!

The space required for foundations (assembly space) is bigger than the minimum space requirement for the equipment.



Original HUCK Bird's Nest

Art. No. 4650



For symbol explanation see folding card at the back

Suspension height: 2.00 m

Suspension height: 2.50 m



ca. Ø 1.20 m

ca. Ø 1.20 m



1.30 m

1.55 m



Minimum distance to the Swing frame: 0.80 m

Meets safety requirements of DIN EN 1176-2

- ⊕ Extra thick padding
- ⊕ Protective chain-link mat
- ⊕ Unbeatable service!
- ⊕ 5 years' guarantee on all materials
- ⊕ Life-long Europe-wide return service for items in need of repair
- ⊕ Fair repair costs



Only trust the Original!

In the HUCK Bird's Nest children play on a close-meshed chain-link mat. The risk of injury is therefore extremely slim. The "chicks" sit on a smooth and gently rounded floor - like their feathered friends in a Bird's Nest.

Of course, there are specific provisions in the play equipment standard as regards padding, which the HUCK bird's nest clearly exceeds.

Another criterion of quality: The extra strong abrasion protection for connecting pieces subjected to great stresses and for suspension chains. Extremely weatherproof and cold-resistant sleeve tubing for the HUCK suspension chains provides optimal protection with regular use - that's why our Bird's Nest is so well-loved!

Even maintenance is child's play: The play equipment can easily be repaired once assembled. All assembled materials come with a 5-year guarantee and with proper care and maintenance the children can play happily on their play equipment for a long time.

HUCK's standard Bird's Nest has a blue wrapping rope - it also come in a choice of green, black, red and natural hemp.

Our experience and our warranty guarantee quality at the highest level - that's HUCK "Made in Germany"!

The "Bird's Nest" name has been a Registered brand name of HUCK-Seiltechnik GmbH for years.

Conclusion: Only trust the original! Because only the HUCK Bird's Nest combines happiness through play, durability and safety.



Use to your advantage the all Original HUCK Bird's Nest swing!

Safety and high play value

- ⊕ Close-meshed chain-link mat
- ⊕ Protection against sliding through or arms or legs slipping through
- ⊕ Nest-shaped base
- ⊕ Extra-thick padding

Premium quality

- ⊕ Additional anti-abrasion protection on Connecting parts
- ⊕ Suspension chains with highest quality.
- ⊕ Weather-resistance and cold-proof
- ⊕ Proof sleeve tubing
- ⊕ 5-year guarantee on all materials

Extremely easy maintenance

- ⊕ Repairs can be made to the nest mat onsite
- ⊕ Replacement parts readily available
- ⊕ HUCK Service with return and redeliveryservice

The benefits of chain-link mats with steel rope chain connection that have been tried and tested 100 times over worldwide can also be seen directly on the used play equipment:



- ⊕ The chain-link base of our Original HUCK Bird's Nest from 2002 shows no sign of damage whatsoever to the plastic links, steel rope or chains

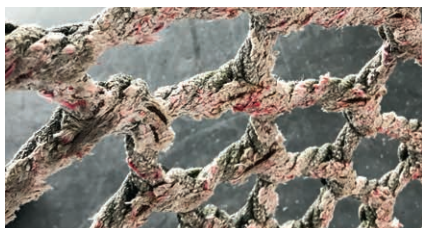

- ⊖ The net base of a nest swing from 2013 has already worn away on its surface so that the knot connection is only held in place by single rope strands. Also, the steel core is already completely open in places and shows signs of rust



* For durable and long-lasting swinging experience: All HUCK nest swings now come with extra strong anti-abrasion protection at the connecting points subjected to stress on the suspension chains for the nest basket and the crossover points on the suspension chains.



Original HUCK Bird's Nest / Options:

Art. No. 4650 / Colours freely selectable on rope wraps and chain sleeve



Black wrapping rope. Black protective chain sleeve.



Blue wrapping rope.
Red protective chain sleeve.



Green wrapping rope.
Red protective chain sleeve.



Red wrapping rope (additional charge),
Black protective chain sleeve.



Beige wrapping rope.
Black protective chain sleeve.



Black wrapping rope.
Black protective chain sleeve.



Black wrapping rope.
Black protective chain sleeve.
Neon green chain link mat.



Green wrapping rope. Red protective chain sleeve.



Original HUCK Honeycomb Nest

Art. No. 4550



Original HUCK Mini Bird's Nest

Art. No. 4650-85



Art. No.	Product description	Diameter	Suspension height	Colour Chain	Chain protective sleeve	Suspension height	
						plank	2.00 m
4550*	Original HUCK Honeycomb Nest	1.00 m	2.00 m or 2.50 m	black, red	1.54 m	1.30 m	1.55 m
4650*	Original HUCK Bird's Nest	1.20 m	2.00 m or 2.50 m	black, red	1.90 m	1.30 m	1.55 m
4650-85*	Original HUCK Mini Bird's Nest	0.90 m	2.00 m or 2.50 m	black, red	1.54 m	1.30 m	1.55 m
4650-85M	Original HUCK Mini Bird's Nest for Mini-M-Swing	0.90 m	1.29 m		Mini-M-Swing 1.43 m	Mini-M-Swing 0.50 m	

*Art. No. 4550/4650/4650-85 are manufactured with suspension chains and sleeve as standard; suspension ropes only on request

Cable color wrapping: green, blue, red (additional charge), black, beige

Colour of suspension cables: green, orange, fluorescent orange, blue, yellow, black, grey, red, beige, turquoise, fuchsia

Mat colours: black and neon green



Universal joint including safety bearing

Art. No. 4608-1

Further information
on page 201.



Mini-M-Swing

Art. No. 4540-10 Posts with suspension bearings without attachments*

Art. No. 4540-10-04 Posts with suspension bearings, powder-coated, without attachments*

Art. No. 4540-10A Set Dig-in ground anchor hot-dip galvanized



For symbol explanation see folding card at the back

Suspension height: 1.29 m

2.30 x 0.90 m

8.70 m²

3.95 x 2.20 m

0.50 m

1.00 m³

4

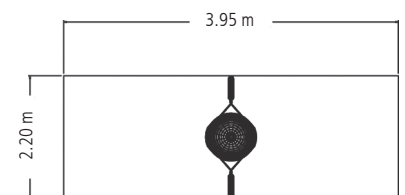

SUPER PRACTICAL!

With dig-in anchors this play equipment is simply set up and can be played on immediately (Art. No. 4540-10A)

Please note!

The space required for foundations (assembly space) is bigger than the minimum space requirement for the equipment.

Now with a lower basket height for an easier start! For the smallest!

*Recommended attachment:

Original HUCK Bird's Nest
Art. No. 4650-85M
(Page 147)

Toddler Swing Seat
Art. No. 4693M
(Page 149)

Swings



Art. No. 4693-10



Art. No. 4693



Art. No. 4693-70



Art. No. 4712



Art. No. 5720-1



Art. No. 4700-08



Art. No. 491



Art. No. 4698-1

 Art. No. 5720
(for private use)

Art. No.	Product description	Design Attachment	Suspension height	Required suspension bearings (Page 200)
4693-10	Baby Seat	Hercules rope, coloured	2.00 - 2.50 m	2x Art. No. 4602 Articulated swing hook
4693	Toddler Swing Seat	Hercules rope, coloured	2.00 - 2.50 m	inclusive 2x Art. No. 4602 Articulated swing hook
4693-70	Double Toddler Swing	Hercules rope, coloured	2.00 - 2.50 m	2x Art. No. 4602 Articulated swing hook
4712	Safty Swing Seat with chain	2.00 m Chain, galvanized	2.50 m	2x Art. No. 4602 Articulated swing hook
5720-1	Swing Seat with chain	2.00 m Chain, galvanized	2.50 m	2x Art. No. 4602 Articulated swing hook
4700-08	Rustic Board Swing (for private use)	14 mm Ø PP-Multi strand rope, beige	2.00 - 2.50 m	2x Art. No. 4602 Articulated swing hook
491	Pendulum Seat with chain	2.00 m chain with sleeve		inclusive Art. No. 4603 Swivel
4698-1	Simple Tyre Swing		2.00 m - 2.50 m	2x Art. No. 4602 Articulated swing hook
5720	Swing Seat	PP-Multi strand rope, blue or white	2.00 - 2.50 m	2x Art. No. 4602

All measured lengths for ground clearance of approx. 40 cm



Art. No. 4610 | 4611



Art. No. 4620



Art. No. 4630

Art. No.	Product description	Design Attachment	Dimensions	Suspension height	Drill-hole distance	Minimum distance to frame	Required suspension bearings (Page 200)
4610	Climbing Chimney without ground anchor	Hercules rope coloured	Ø 70 cm	2.00 or 2.50 m	-	1.00 m	Inclusive 1x Art. No. 4608-2 Universal Joint
4611	Climbing Chimney with ground anchor	Hercules rope coloured	Ø 70 cm	2.00 or 2.50 m	-	0.70 m	Inclusive 1x Art. No. 4608-2 Universal Joint
4620	Rope Ring Swing Carousel without ground anchor	Hercules rope coloured	Ø 70 cm	2.00 or 2.50 m	-	1.00 m	Inclusive 1x Art. No. 4608-2 Universal Joint
4630	Oval Rope Swing	2x v-shaped chain, red chain sleeves	1.05 x 0.60 m	2.00 or 2.50 m	0.70 m	0.80 m	Inclusive 2x Art. No. 4608-3 Articulated swing hook



Art. No. 4695



Art. No. 4695-30



Art. No. 4696

Art. No.	Product description	Design Attachment	Dimensions	Suspension height	Drill-hole distance	Minimum distance to frame	Required suspension bearings (Page 200)
4695	Swing Seat Maxi	2x v-shaped chain, red chain sleeves	0.80 x 1.10 x 0.80 m	2.00 or 2.50 m	0.80 m	0.70 m	Inclusive 2x Art. No. 4608-3 Articulated swing hook
4695-30	Swing Seat Midi	2x v-shaped chain, red chain sleeves	0.60 x 0.90 x 0.60 m	2.00 or 2.50 m	0.55 or 0.60 m	0.65 m	Inclusive 2x Art. No. 4608-3 Articulated swing hook
4696	Swing Seat Mini	2x v-shaped Hercules rope, red and green	0.60 x 0.30 x 1.20 m	2.00 or 2.50 m	0.55 or 0.60 m	0.65 m	Inclusive 2x Art. No. 4608-3 Articulated swing hook

All length dimensions for ground clearance of approx. 40 cm



Art. No. 4771-08



Art. No. 4772-08

Art. No.	Product description	Design Attachment	Dimensions	Suspension height	Minimum distance to frame	Required suspension bearings (Page 200)
4771-08	Partner Swing "Rustikal"	3x suspension chains with red Chain sleeve	140 x 140 mm, Width approx. 1.70 m	2.00 or 2.50 m	0.60 m	3x Art. No. 4602 Articulated swing hook
4772-08	Trio Swing	4x suspension chains with red Chain sleeve	140 x 140 mm, Width approx. 1.90 m	2.00 or 2.50 m	0.60 m	4x Art. No. 4602 Articulated swing hook



Art. No. 4585-40



Art. No. 4770-08-200 | 4770-08-250



Art. No. 4651-20

Art. No.	Product description	Design Attachment	Dimensions	Suspension height	Drill-hole distance	Minimum distance to frame	Required suspension bearings (Page 200)
4585-40	Rope-end Swing	Hercules rope coloured	140 x 140 mm, Length approx. 1.90 m	2.00 or 2.50 m	1.90 m	0.90 m	2x Art. No. 4608 Universal Joint
4770-08-200/250	Jungle Rope Swing	2 x Chain 8 mm galvanized	90 x 90 mm, Total length approx. 3.60 m	2.00 or 2.50 m	2.00 m	0.70 m	2x Art. No. 4608 Universal Joint
4651-20	Swing Bed	4 x Hercules rope coloured	1.20 x 0.90 m	2.00 - 2.50 m	-	0.80 m	Art. No. 4608-1 Universal Joint Incl. safety bearings



Plastic Link Hammock

with links and steel rope

Art. No. 806



For symbol explanation see folding card at the back

Lying area: 0.80 x 1.80 m



1.60 m



4.65 x 0.90 m



16.90 m²



4.90 x 3.90 m



0.65 m



5



Technical data is based on specific example and changes according to installation height

Please note!
The space required for foundations (assembly space) is bigger than the minimum space requirement for the equipment.

Band Hammock

Art. No. 807



For symbol explanation see folding card at the back

Lying area: 0.80 x 1.95 m



1.60 m



4.65 x 0.90 m



16.90 m²



4.90 x 3.90 m



0.65 m



5



Technical data is based on specific example and changes according to installation height

Please note!
The space required for foundations (assembly space) is bigger than the minimum space requirement for the equipment.

Posts for hammocks incl. suspension bearings

Art. No. 805S Steel posts / Ø 102 mm, Length 2.50 m

Art. No. 805PS Douglas fir posts / Ø 180 mm, Length 2.70 m with post shoes

Art. No. 805R Robinia wood posts / Ø 160-200 mm, Length 2.50 m with steel shoes



Hercules Rope Hammock with clip fixings

Art. No. 808VA









Hercules Rope Hammock with cross-stitch

Art. No. 808KS



For symbol explanation see
folding card at the back

Lying area: 0.80 x 1.80 m







	1.60 m
	4.65 x 0.90 m
	16.90 m ²
	4.90 x 3.90 m
	0.65 m
	5
	

Technical data is
based on specific
example and
changes according
to installation
height

Please note!
The space required for
foundations (assembly
space) is bigger than
the minimum space
requirement for
the equipment.

For symbol explanation see
folding card at the back

Lying area: 0.80 x 1.80 m

	1.60 m
	4.65 x 0.90 m
	16.90 m ²
	4.90 x 3.90 m
	0.65 m
	5
	

Technical data is
based on specific
example and
changes according
to installation
height

Please note!
The space required for
foundations (assembly
space) is bigger than
the minimum space
requirement for
the equipment.











Polyester Hammock

Art. No. 807-200



For symbol explanation see folding card at the back

-  Lying area: 0.65 x 1.50 m
-  1.44 m
-  3.15 x 0.65 m
-  14.20 m²
-  4.40 x 3.65 m
-  0.65 m
-  2
- 

Technical data is based on specific example and changes according to installation height

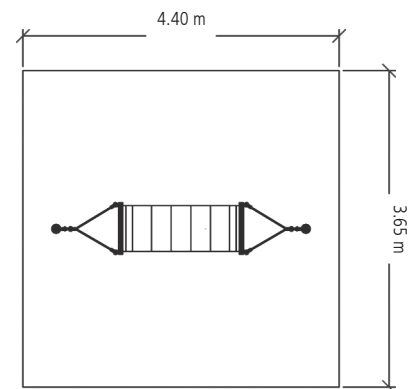

Steel posts for polyester Hammocks incl. Suspension bearings
Art. No. 805-200

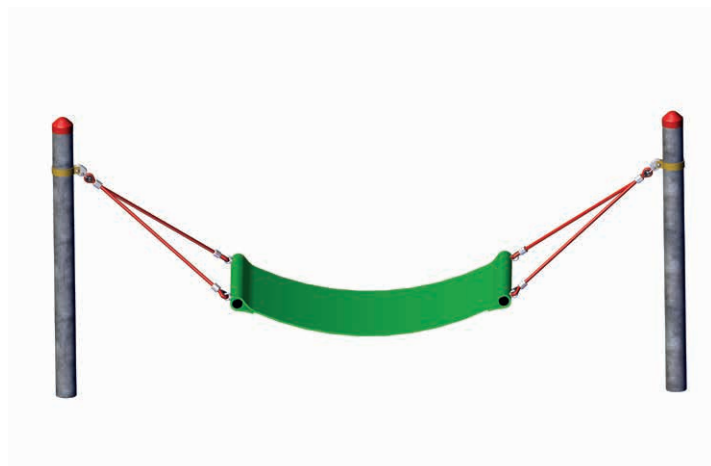





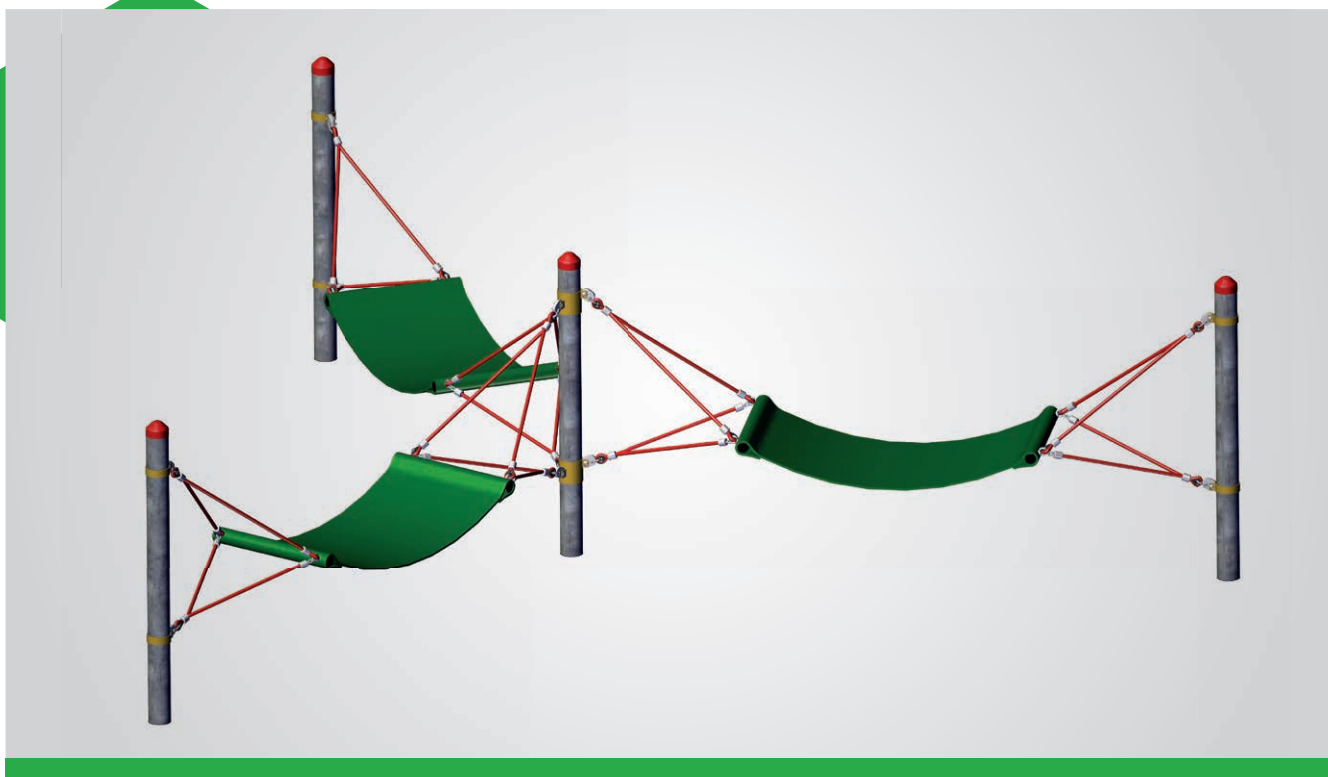



Hammock Trio

Art. No. 807-100



For symbol explanation see folding card at the back

Lying area: 0.65 x 1.50 m (3x)

-  1.44 m
-  Ø 6.15 m
-  31.90 m²
-  6.60 x 6.60 m
-  0.70 m
-  1.55 m³
-  15
- 

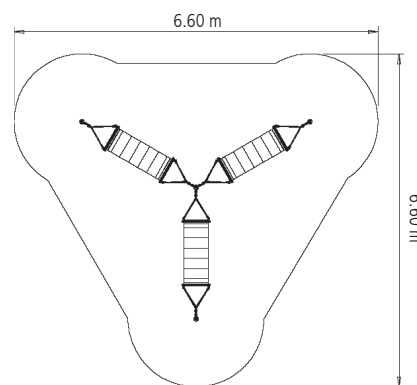

Other options on request.

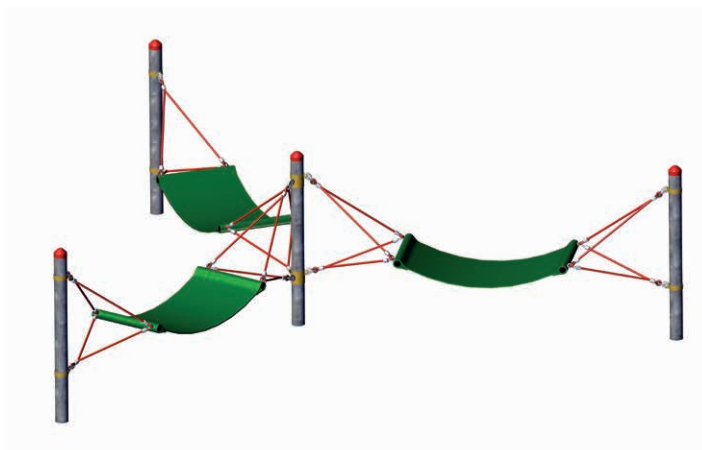

Equipment
4 Steel posts (Ø 102 mm),
length 2.40 m











XXL-Hammock for Arch Steel Frame

Art. No. 808-2



For symbol explanation see folding card at the back

Lying area: 2.00 x 1.40 m

-  1.35 m
-  4.45 x 4.15 m
-  20.60 m²
-  4.55 x 5.00 m
-  0.60 m
-  2.50 m³
-  7
- 

Please note!
The space required for foundations (assembly space) is bigger than the minimum space requirement for the equipment.

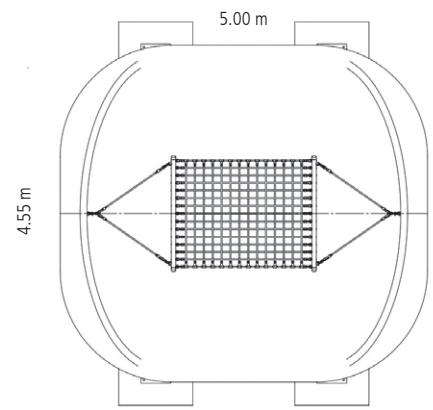

Arch Steel Frame for XXL Hammock
incl. suspension bearings
Art. No. 805SB Steel, Ø 159 mm

Hercules Rope Hammock with plastic knotballs

Art. No. 808

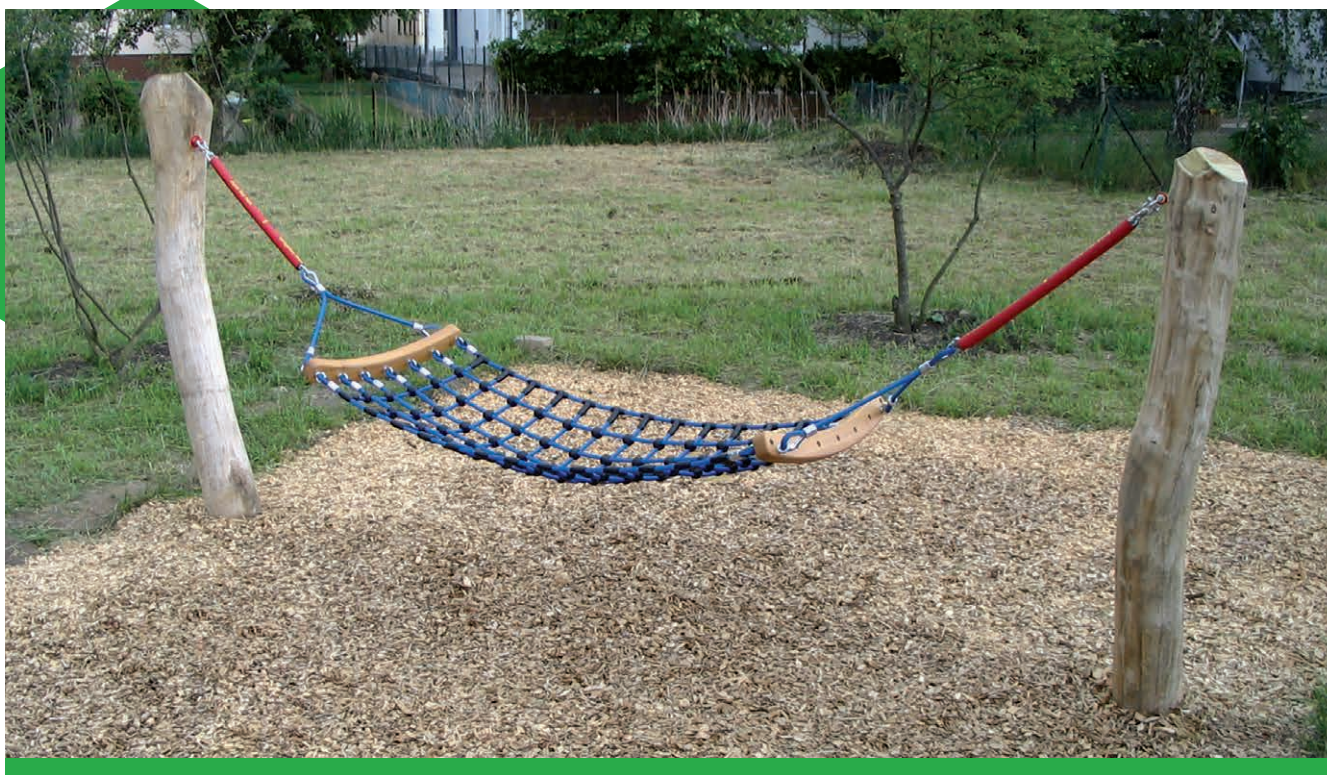

For symbol explanation see folding card at the back

Lying area: 0.81 x 1.80 m



1.60 m



4.65 x 0.90 m



16.90 m²



4.90 x 3.90 m



0.65 m



5



Technical data is based on specific example and changes according to installation height

Equipment
Hammock without posts







XXL Rest Hammocks

Art. No. 808-1



For symbol explanation see folding card at the back

Lying area: 2.00 x 1.40 m

-  1.75 m
-  5.20 x 1.60 m
-  21.00 m²
-  5.00 x 4.60 m
-  0.60 m
-  1.15 m³
-  7
- 
- 

Please note!
The space required for foundations (assembly space) is bigger than the minimum space requirement for the equipment.

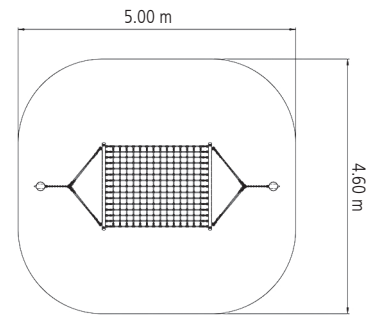

Posts for XXL Rest Hammocks,
incl. suspension bearings
Art. No. 808-1S Steel (Ø 159 mm), Length 2.70 m

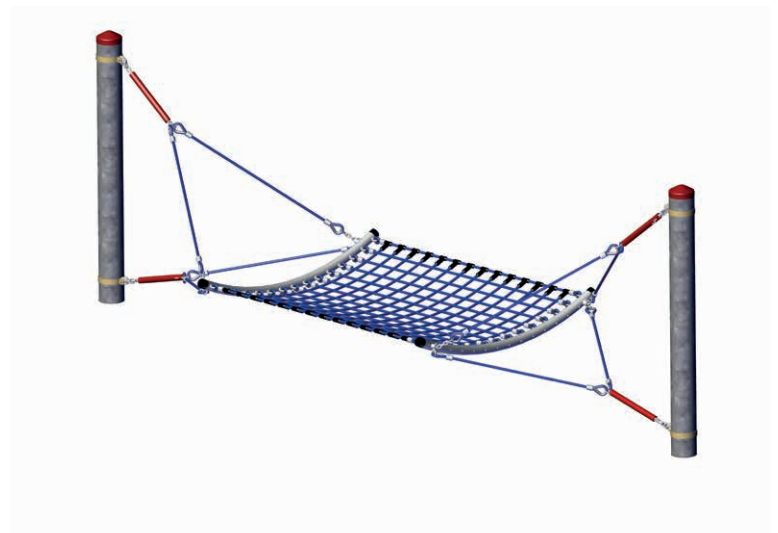

Bird's Nest "Chill Out" XXL









Art. No. 803

Art. No. 803-US IPEMA-certified



For symbol explanation see folding card at the back

Lying area: Ø 1.80 m

-  2.15 m
-  4.85 x 1.95 m
-  19.30 m²
-  Ø 4.95 m
-  0.75 m
-  1.20 m³
-  8
- 
- 

Equipment
2 Steel posts (Ø 159 mm),
length 3.00 m

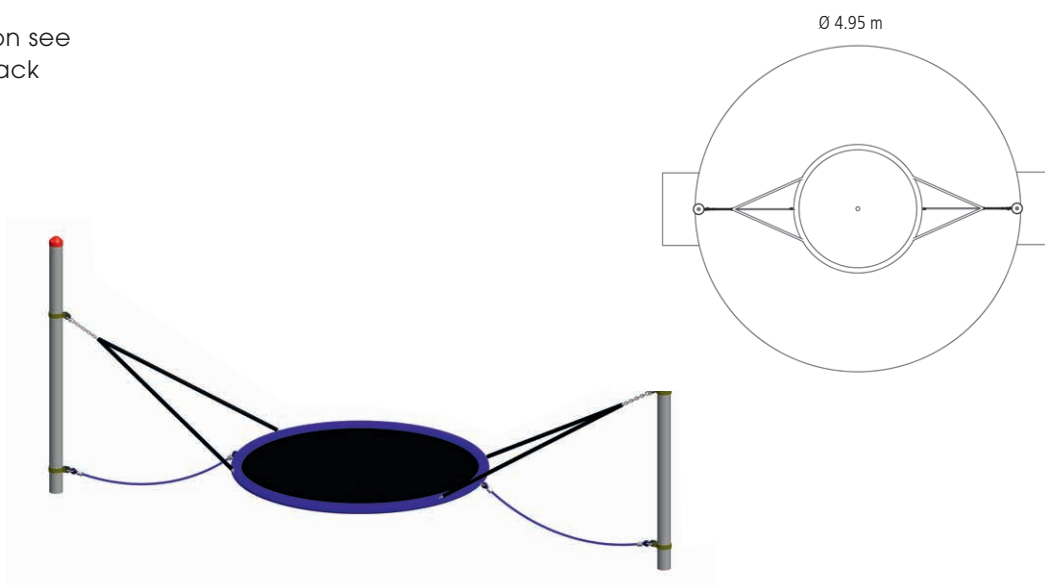

Please note!

The space required for foundations (assembly space) is bigger than the minimum space requirement for the equipment.

- ⊕ Perfect as a group swing for little ones
- ⊕ Perfect as a therapy swing for adults
- ⊕ Swinging motion can be individually controlled
- ⊕ 5-year full guarantee



LET'S PLAY!



ROPE NET PYRAMIDS

Our rope pyramids combine it all in one big adventure. Whether in kindergartens, public playgrounds, schools or adventure parks. Extraordinary heights can be safely reached by our varying net levels or nest baskets. Where you can relax and enjoy the view.

PRODUCT-HIGHLIGHTS

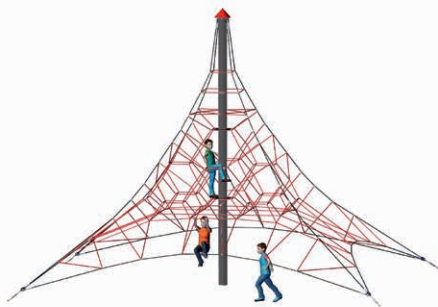

SPIDER 6 Pyramid with 4 guy lines
| 164 |

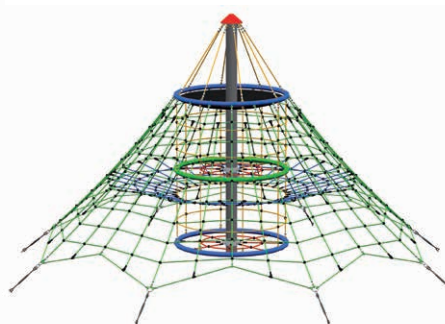

Rope Net Pyramid DINO 2
| 175 |

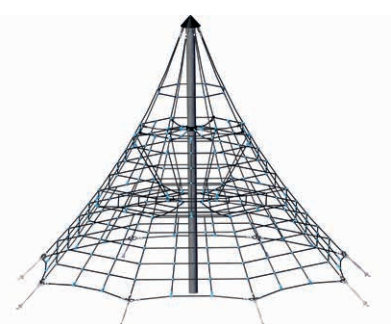

Net Pyramid Black Space
| 181 |













Triops®-Pyramid Mini

Art. No. 4644-1



For symbol explanation see folding card at the back

-  3.25 m
-  4.00 x 4.60 m
-  17.10 m²
-  4.80 x 4.60 m
-  0.65 m
-  1.30 m³
-  10
- 

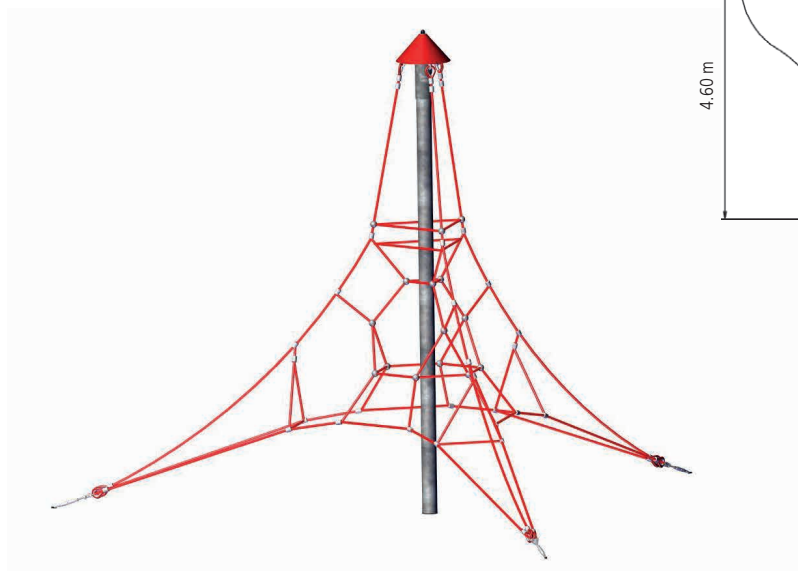









SPIDER 4 Pyramid with 4 guy lines

Art. No. 5000-4-4



For symbol explanation see folding card at the back

-  4.35 m
-  5.90 x 5.90 m
-  52.20 m²
-  7.80 x 7.80 m
-  0.95 m
-  8.70 m³
-  25
- 

Please note!

The space required for foundations (assembly space) is bigger than the minimum space requirement for the equipment.

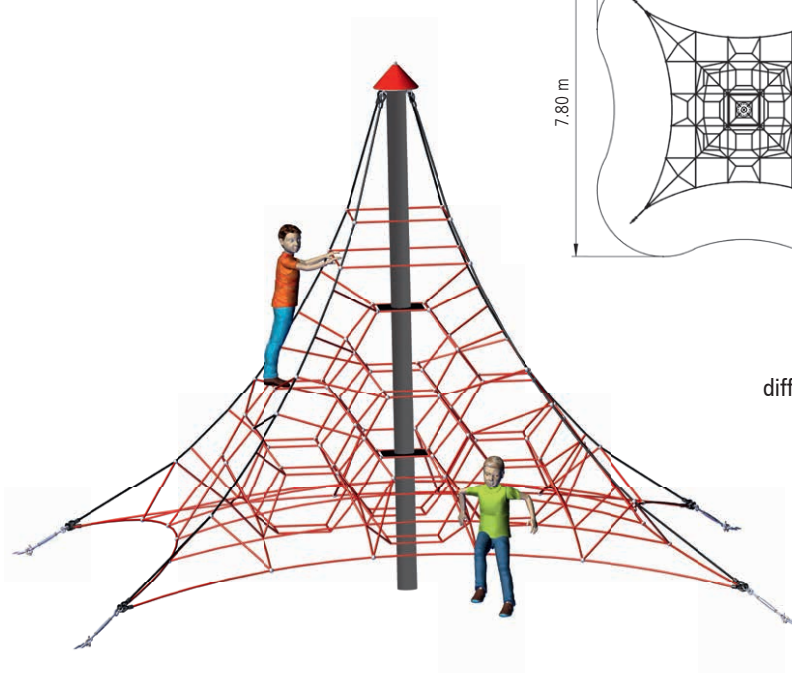
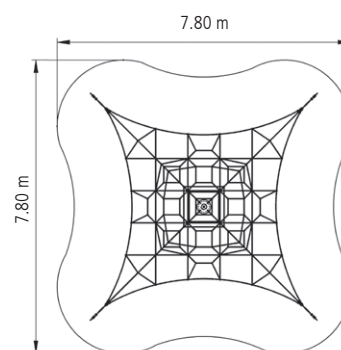

Available in different colours.











SPIDER 6 Pyramid with 4 guy lines

Art. No. 5000-6-4



For symbol explanation see folding card at the back

-  6.40 m
-  8.75 x 8.75 m
-  97.30 m²
-  10.40 x 10.40 m
-  1.85 m
-  8.70 m³
-  62
- 

Please note!

The space required for foundations (assembly space) is bigger than the minimum space requirement for the equipment.

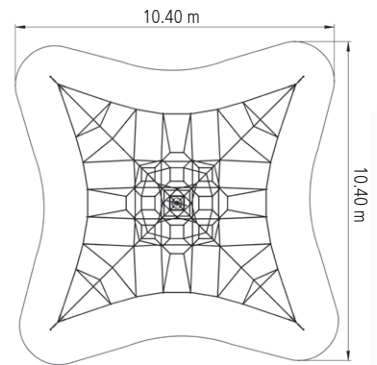

Available in different colours.

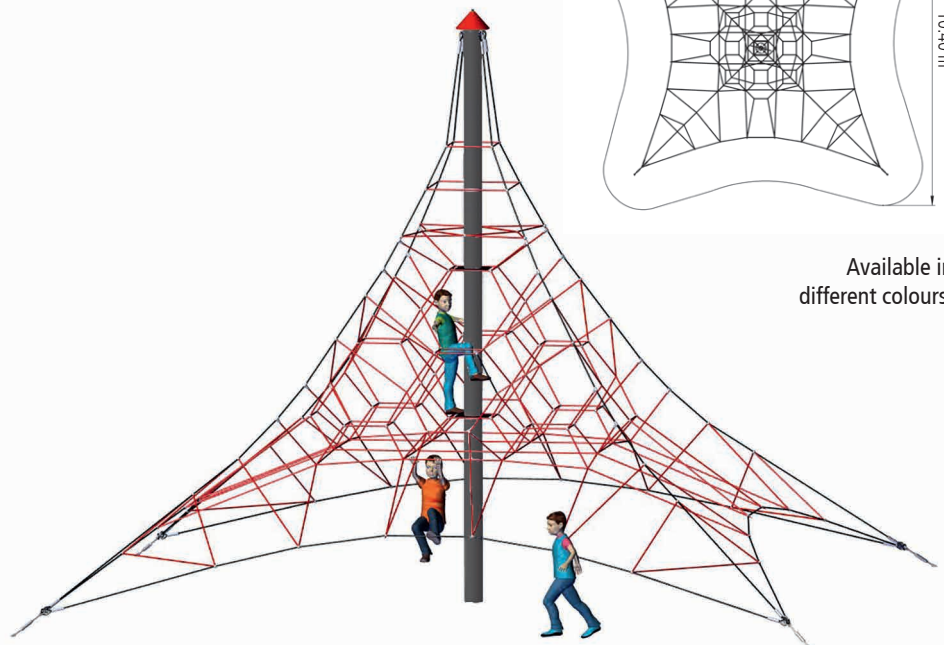

SPIDER 6 Pyramid with 6 guy lines

Art. No. 5000-6-6



For symbol explanation see folding card at the back

-  6.40 m
-  11.30 x 9.80 m
-  109.00 m²
-  11.80 x 11.60 m
-  1.60 m
-  12.80 m³
-  76
- 

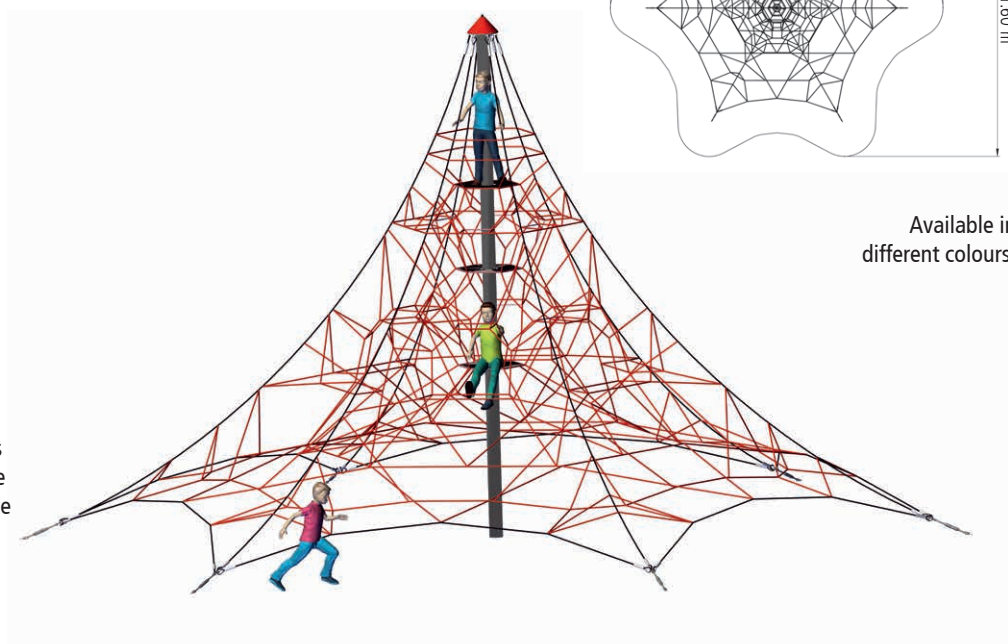
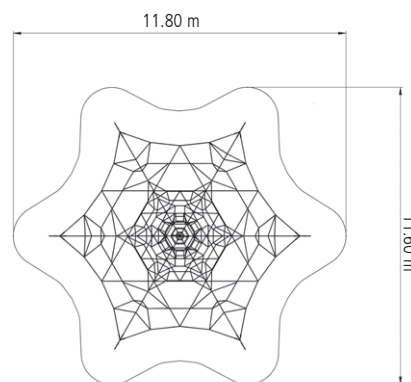

Available in different colours.

Please note!
The space required for foundations (assembly space) is bigger than the minimum space requirement for the equipment.



SPIDER 8 Pyramid with 6 guy lines

Art. No. 5000-8-6



For symbol explanation see folding card at the back

-  8.15 m
-  12.10 x 13.95 m
-  118.00 m²
-  12.50 x 11.90 m
-  1.80 m
-  12.70 m³
-  76
- 

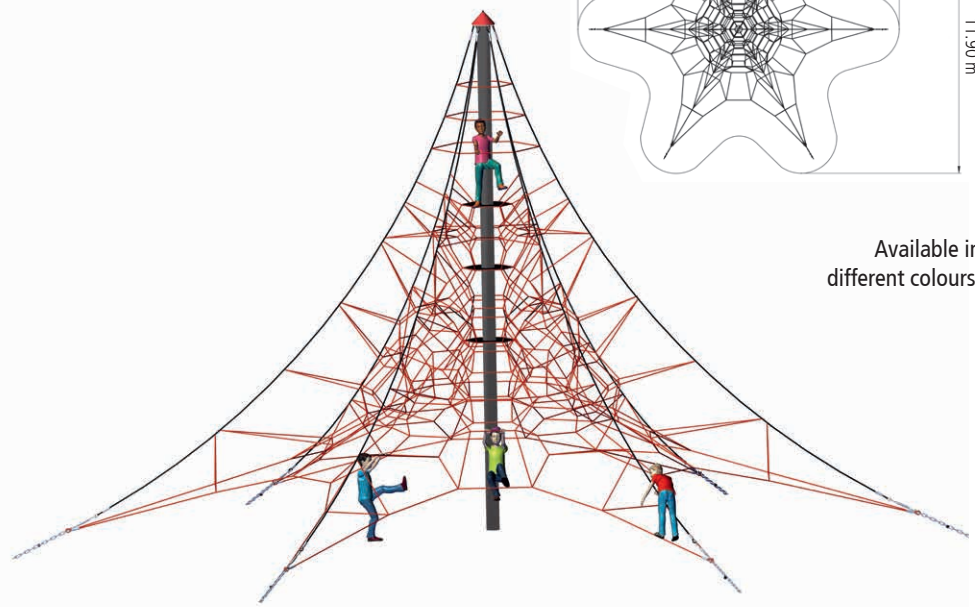
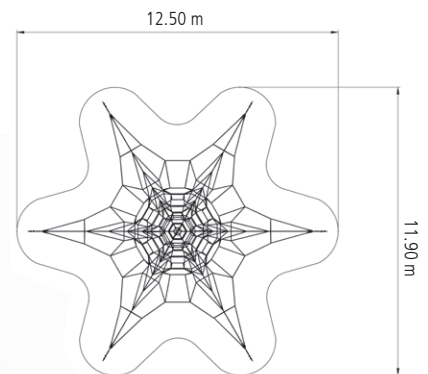

Available in different colours.

Please note!
The space required for foundations (assembly space) is bigger than the minimum space requirement for the equipment.

Cheops-Pyramid Maxi









Art. No. 4643-3B

Art. No. 4643-3B-US, with alu turnbuckles

Art. No. 4643-3E, to dig-in version



For symbol explanation see folding card at the back

-  5.70 m
-  Ø 11.00 m
-  103.00 m²
-  Ø 11.20 m
-  1.75 m
-  4.50 m³
-  76
- 
- 

Please note!

The space required for foundations (assembly space) is bigger than the minimum space requirement for the equipment.

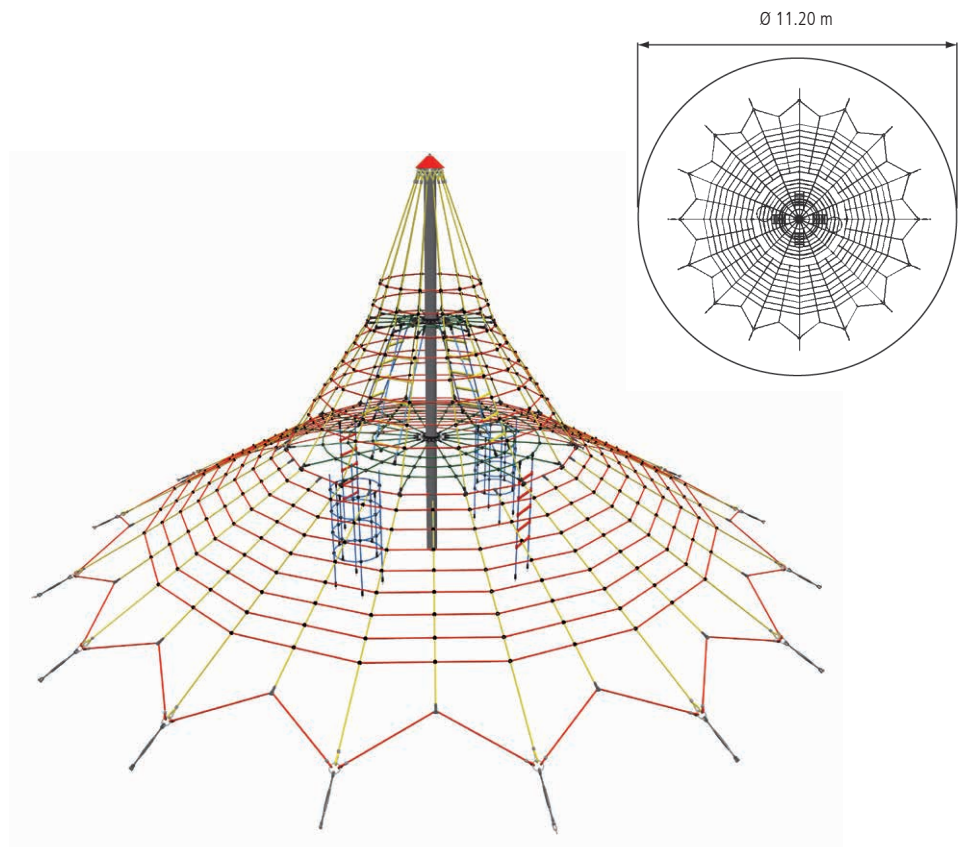



Cheops-Pyramid Midi









Art. No. 4643-2B

Art. No. 4643-2B-US, with alu turnbuckles

Art. No. 4643-2E, to dig-in version



For symbol explanation see folding card at the back

-  4.20 m
-  Ø 8.35 m
-  73.00 m²
-  Ø 9.80 m
-  1.50 m
-  4.50 m³
-  40
- 
- 

Please note!

The space required for foundations (assembly space) is bigger than the minimum space requirement for the equipment.

Ø 9.80 m

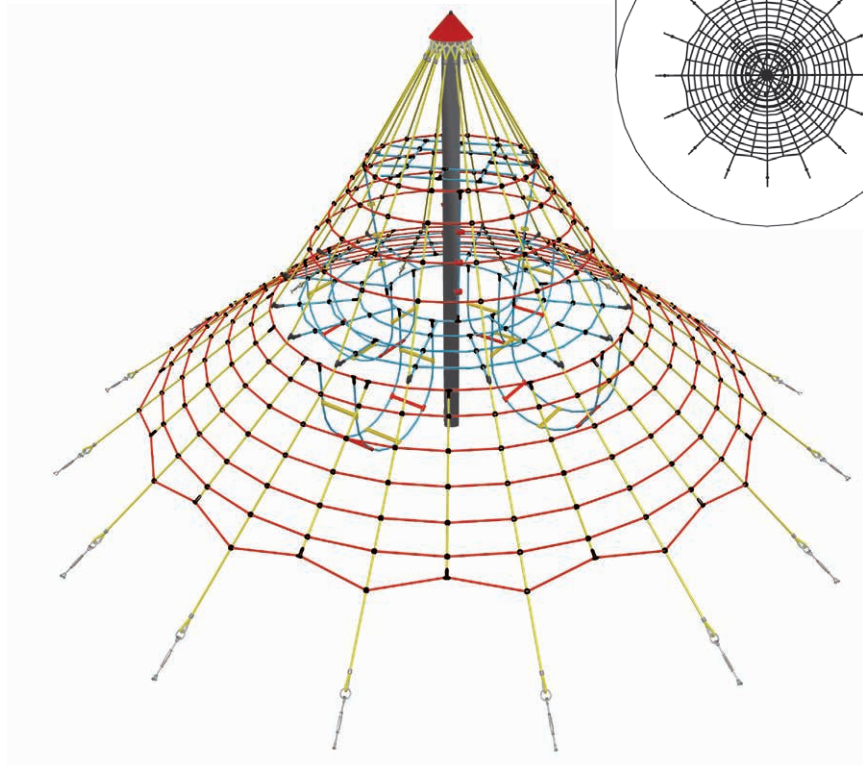
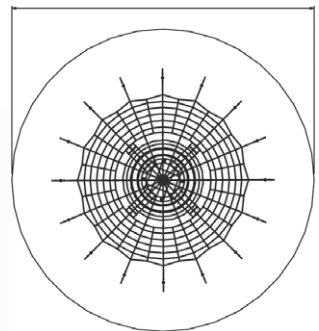





Cheops-Combination Midi

Art. No. 4643-2B-10



For symbol explanation see folding card at the back

-  4.20 m
-  18.85 x 8.35 m
-  139.60 m²
-  17.60 x 9.60 m
-  1.50 m
-  13.00 m³
-  92
- 

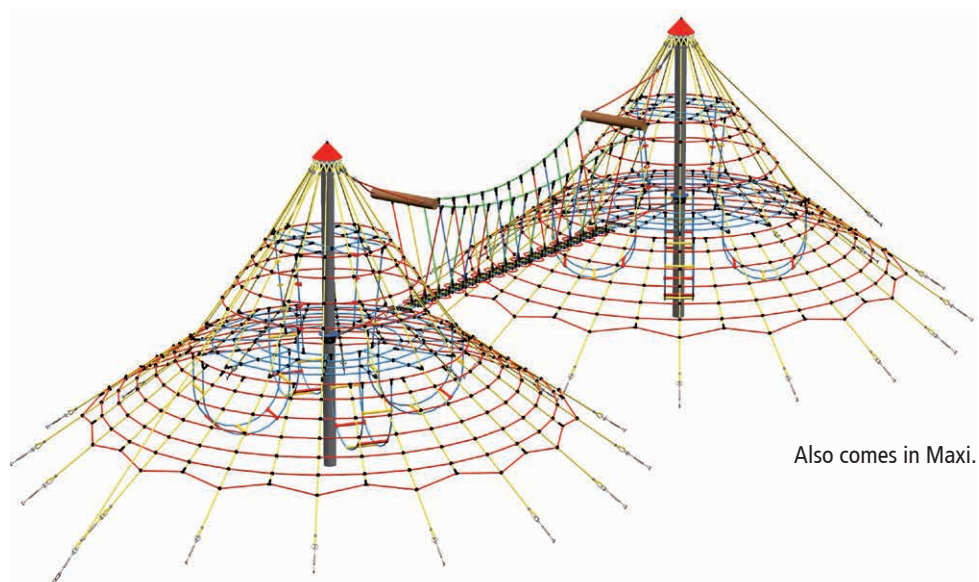
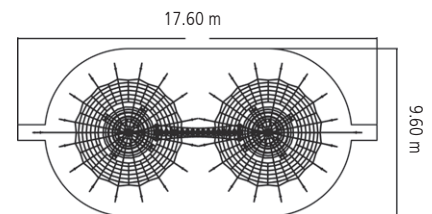

Also comes in Maxi.

Please note!
The space required for foundations (assembly space) is bigger than the minimum space requirement for the equipment.



Cheops-Pyramid Mini

Art. No. 4643-1B

Art. No. 4643-1B-US, with alu turnbuckles

Art. No. 4643-1E, to dig-in version



For symbol explanation see folding card at the back



3.50 m



Ø 4.05 m



33.20 m²



Ø 6.50 m



1.20 m



4.60 m³



31

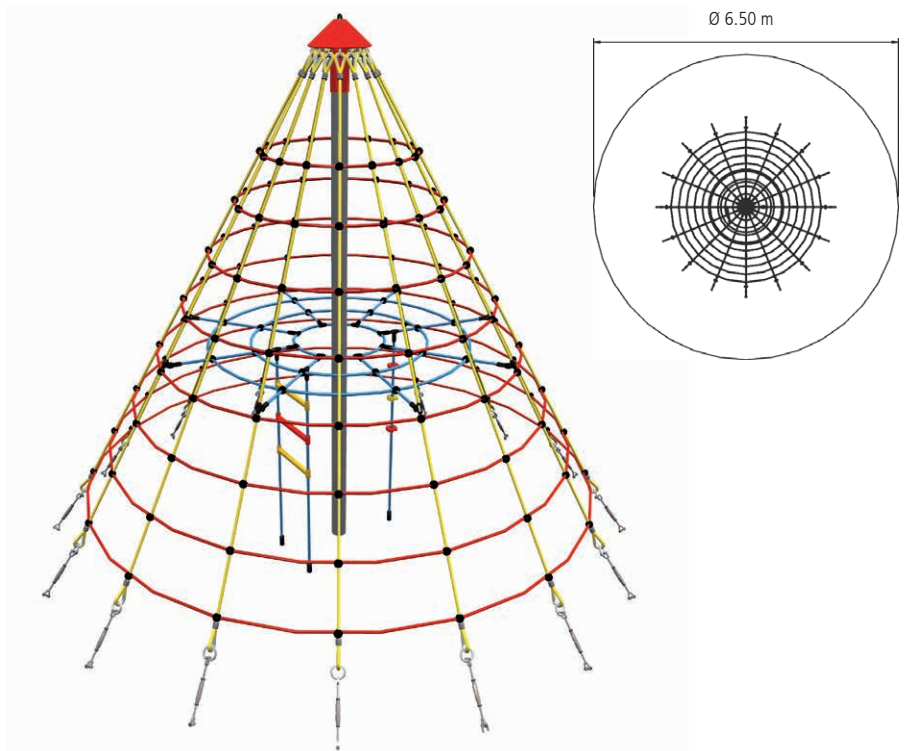

Please note!

The space required for foundations (assembly space) is bigger than the minimum space requirement for the equipment.











Rope Net Tower 1

Art. No. 4595

Art. No. 4595E, to dig-in version



For symbol explanation see folding card at the back

-  6.05 m
-  Ø 9.50 m
-  105.00 m²
-  Ø 11.60 m
-  2.00 m
-  4.30 m³
-  58
- 
- 

Please note!

The space required for foundations (assembly space) is bigger than the minimum space requirement for the equipment.

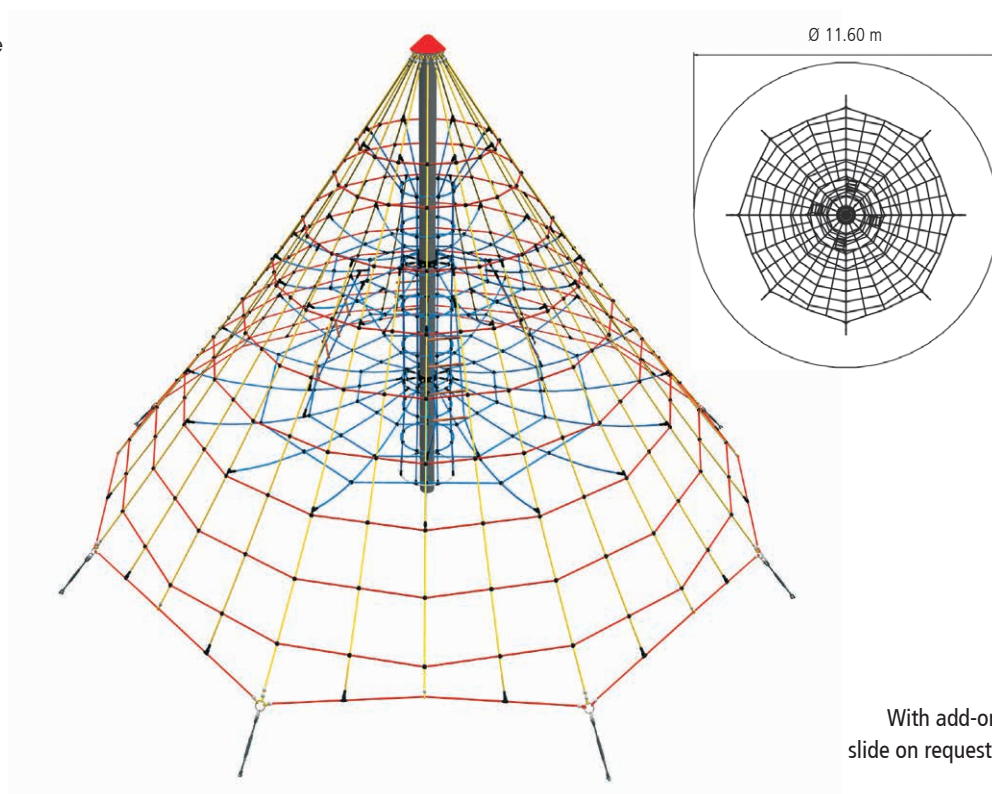

With add-on slide on request!











Rope Net Tower 2

Art. No. 4596S

Art. No. 4596E, to dig-in version



For symbol explanation see folding card at the back

-  4.35 m
-  Ø 8.00 m
-  78.55 m²
-  Ø 10.00 m
-  1.50 m
-  4.50 m³
-  45
- 
- 

Please note!

The space required for foundations (assembly space) is bigger than the minimum space requirement for the equipment.

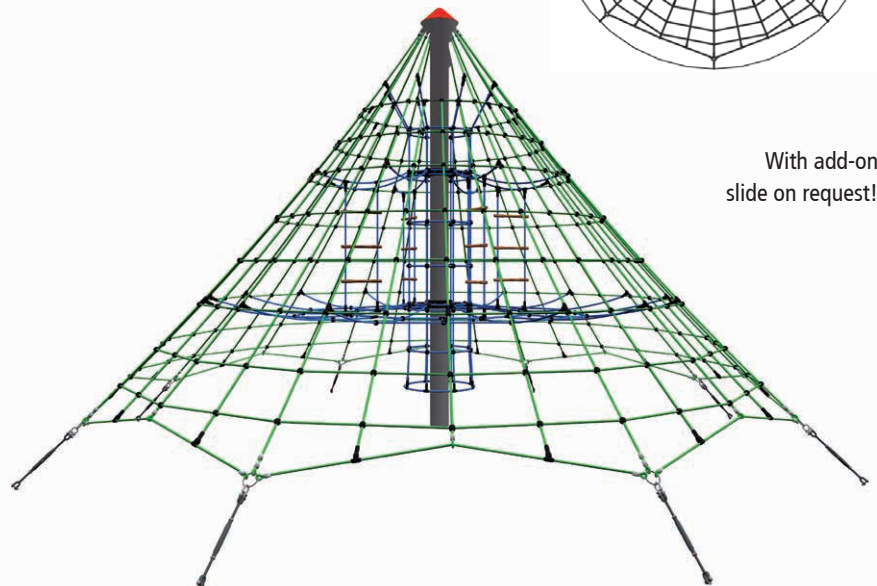
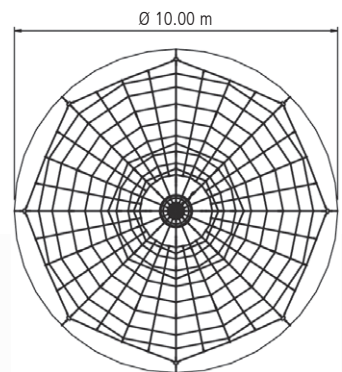

With add-on slide on request!











Rope Net Pyramid DINO XXL

Art. No. 10.04.100



For symbol explanation see folding card at the back

-  8.20 m
-  Ø 9.55 m
-  95.00 m²
-  Ø 11.00 m
-  1.75 m
-  4.30 m³
-  76
- 

Please note!

The space required for foundations (assembly space) is bigger than the minimum space requirement for the equipment.

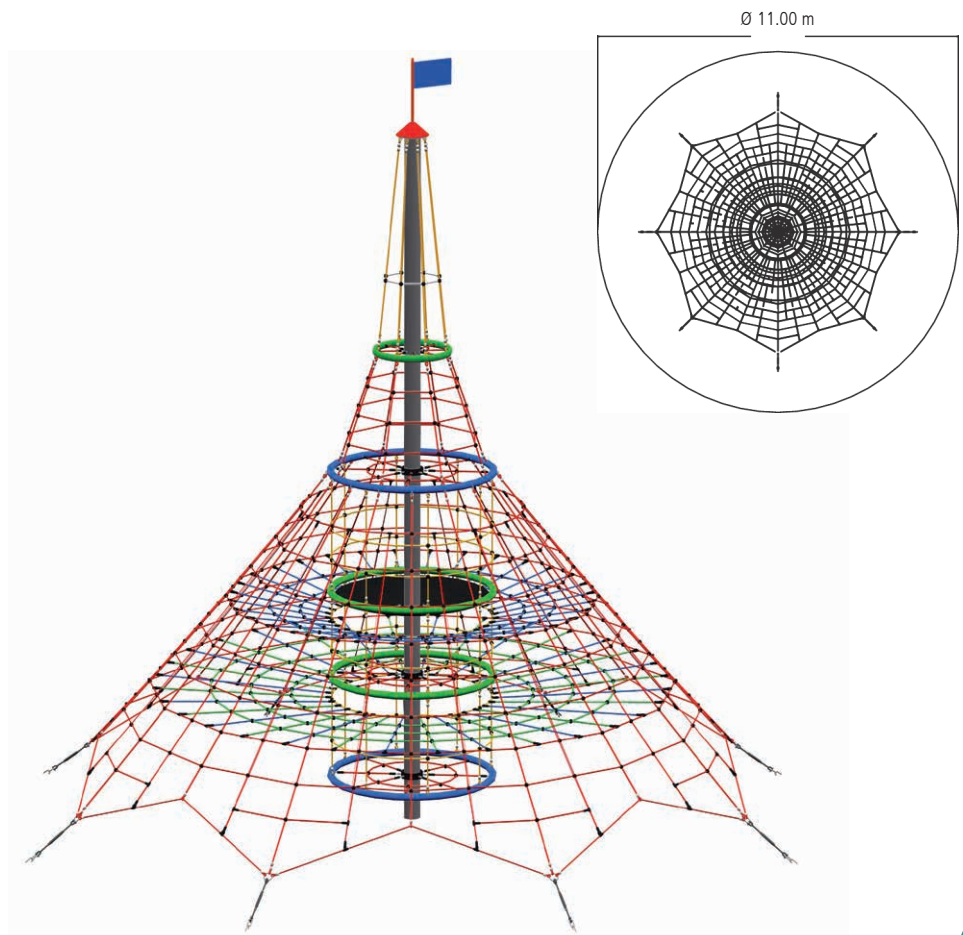











Rope Net Pyramid DINO 1

Art. No. 10.01.100S

Art. No. 10.01.100E, to dig-in version



For symbol explanation see folding card at the back

-  6.15 m
-  Ø 9.55 m
-  95.00 m²
-  Ø 11.00 m
-  1.75 m
-  4.30 m³
-  70
- 
- 

Please note!

The space required for foundations (assembly space) is bigger than the minimum space requirement for the equipment.

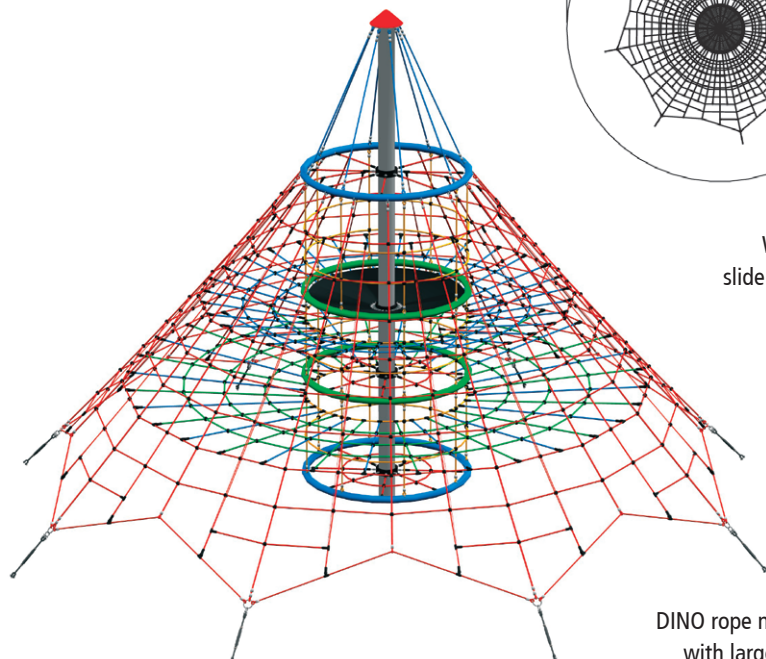
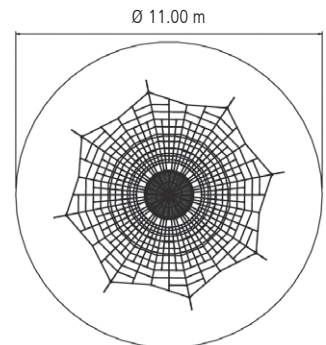

With add-on slide on request!

DINO rope net pyramids with large bird's nest for chilling out.











Rope Net Pyramid DINO 2

Art. No. 10.02.100S

Art. No. 10.02.100E, to dig-in version



For symbol explanation see folding card at the back

-  4.45 m
-  Ø 7.75 m
-  66.50 m²
-  Ø 9.20 m
-  1.50 m
-  4.30 m³
-  45
- 
- 

Please note!

The space required for foundations (assembly space) is bigger than the minimum space requirement for the equipment.

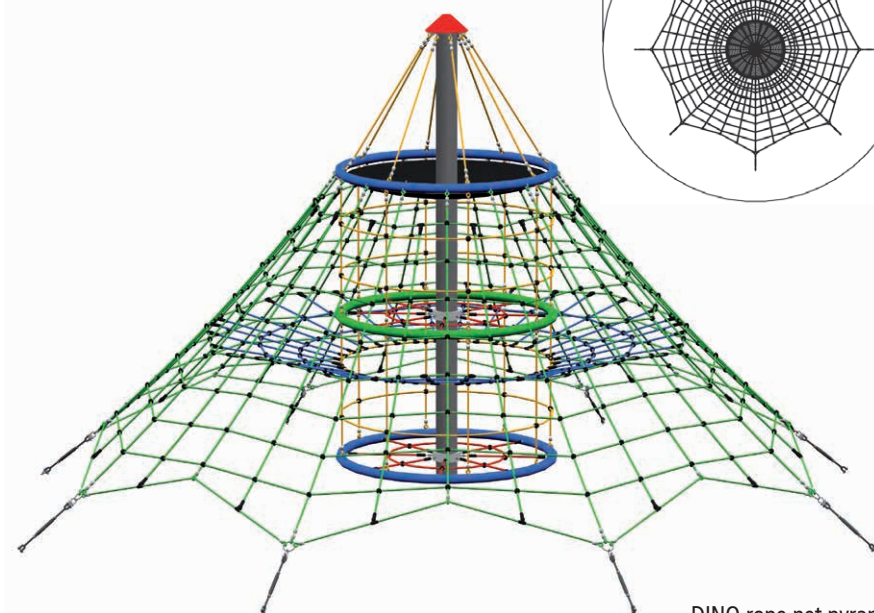
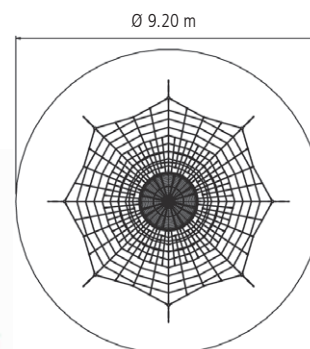

DINO rope net pyramids with large bird's nest for chilling out.











Rope Net Pyramid DINO 3

Art. No. 10.03.100S

Art. No. 10.03.100E, to dig-in version



For symbol explanation see folding card at the back

-  3.20 m
-  Ø 5.60 m
-  35.00 m²
-  Ø 6.70 m
-  1.75 m
-  3.10 m³
-  27
- 
- 

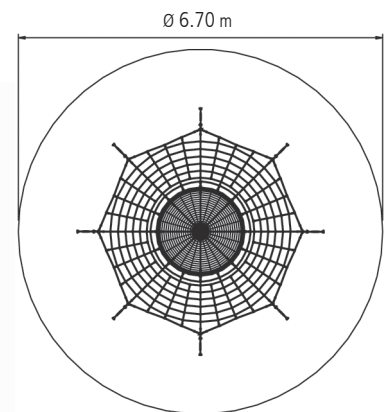
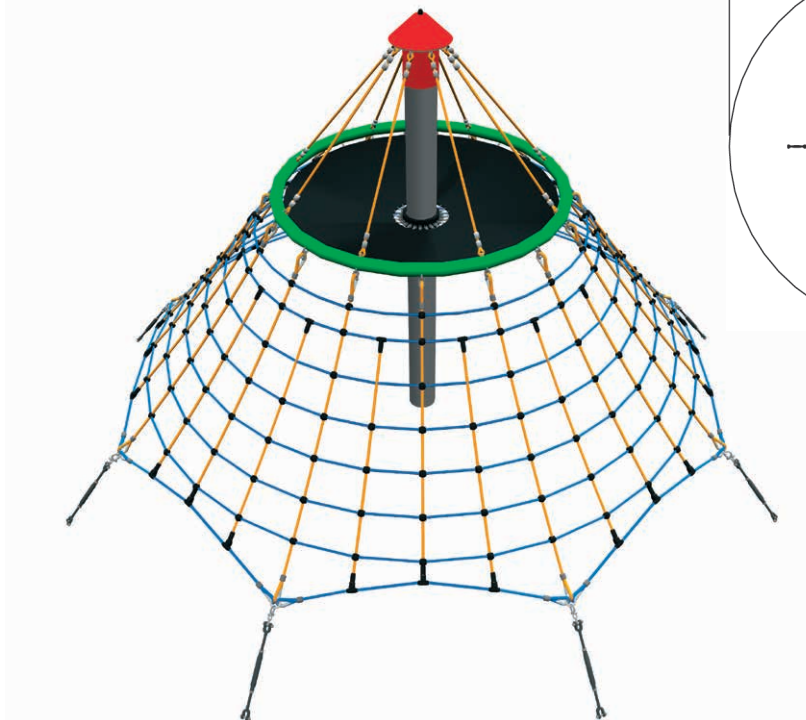









DINO rope net pyramids
with large bird's nest
for chilling out.

Rope Net Pyramid DINO Mini

Art. No. 10.05.100



For symbol explanation see folding card at the back

-  2.25 m
-  3.70 x 3.50 m
-  25.00 m²
-  5.80 x 5.65 m
-  0.80 m
-  0.90 m³
-  13
- 

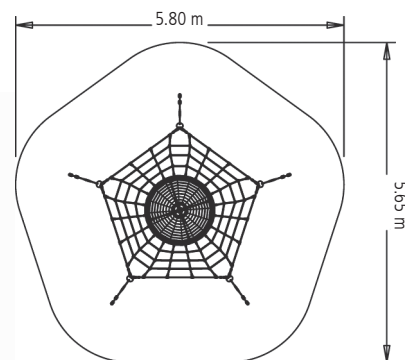

DINO rope net pyramids with large bird's nest for chilling out.







Super-Climb Maxi

Art. No. 4641-1

Art. No. 4641-1E, to dig-in version



For symbol explanation see folding card at the back

-  5.55 m
-  5.90 x 5.90 m
-  72.20 m²
-  8.60 x 8.60 m
-  2.00 m
-  4.30 m³
-  53
- 
- 

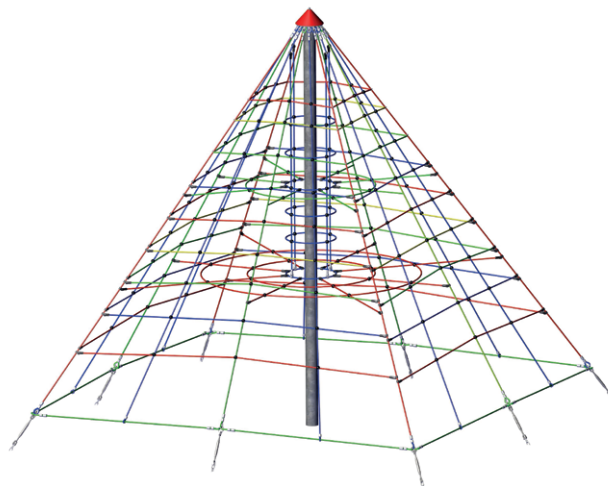
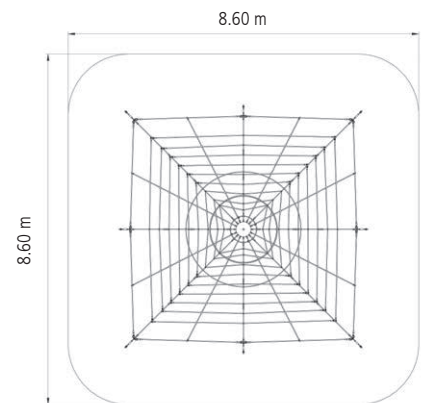

Super-Climb Midi

Art. No. 4641-2
 Art. No. 4641-2E, to dig-in version











Super-Climb Mini

Art. No. 4641-3
 Art. No. 4641-3E, to dig-in version







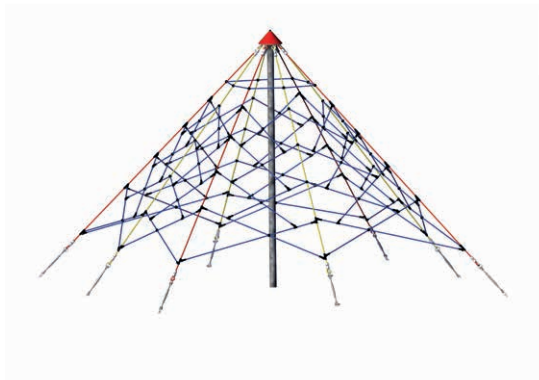
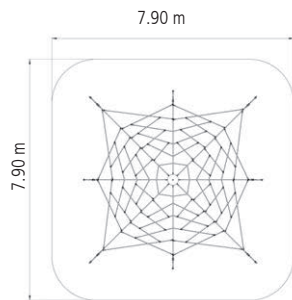



For symbol explanation see folding card at the back

-  3.95 m
-  6.10 x 6.10 m
-  60.00 m²
-  7.90 x 7.90 m
-  3.00 m
-  2.10 m³
-  39
- 
- 



For symbol explanation see folding card at the back

-  2.40 m
-  4.00 x 4.00 m
-  37.75 m²
-  6.30 x 6.30 m
-  1.80 m
-  0.75 m³
-  19
- 
- 

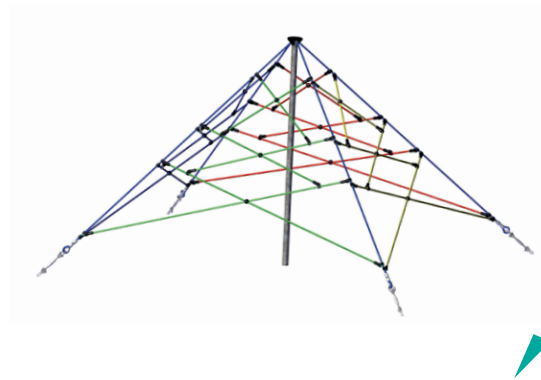
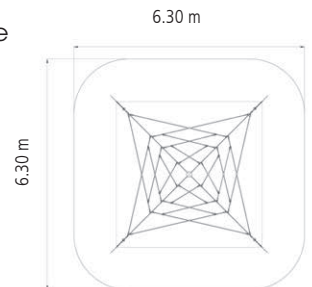











X-Pyramid Maxi

Art. No. 4640-1

Art. No. 4640-1-US, with alu turnbuckles



For symbol explanation see folding card at the back

-  4.20 m
-  5.45 x 5.45 m
-  59.30 m²
-  7.85 x 7.85 m
-  3.00 m
-  1.15 m³
-  28
- 

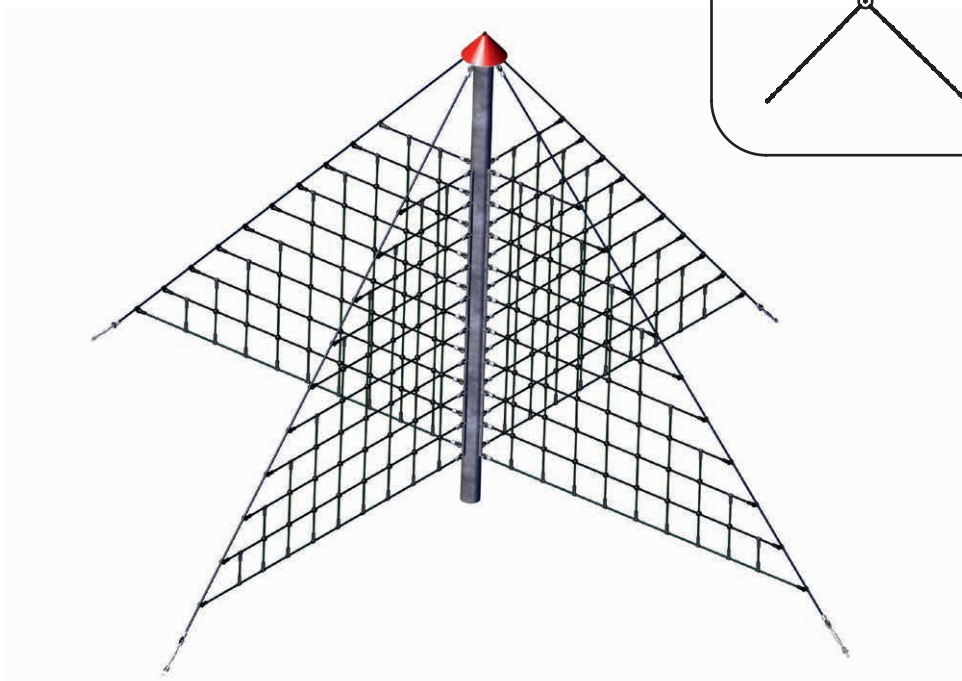
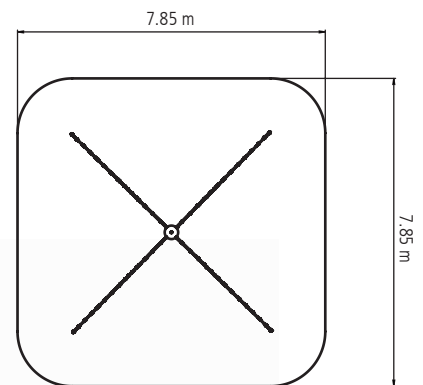









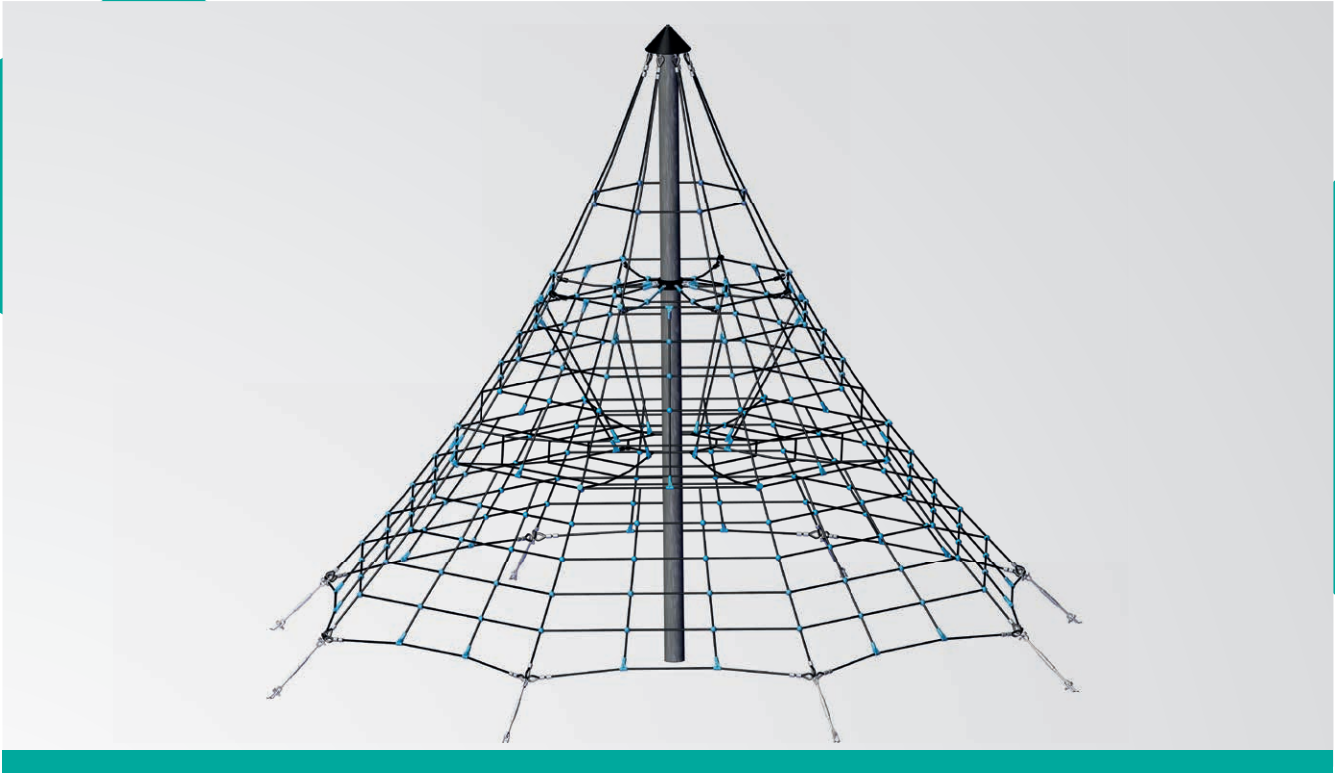

NEW FOR 2022

Deep Space Net Pyramid

Art. No. 4641-10S



For symbol explanation see folding card at the back

-  5.20 m
-  Ø 7.00 m
-  65.50 m²
-  Ø 9.00 m
-  1.80 m
-  4.00 m³
-  48
- 

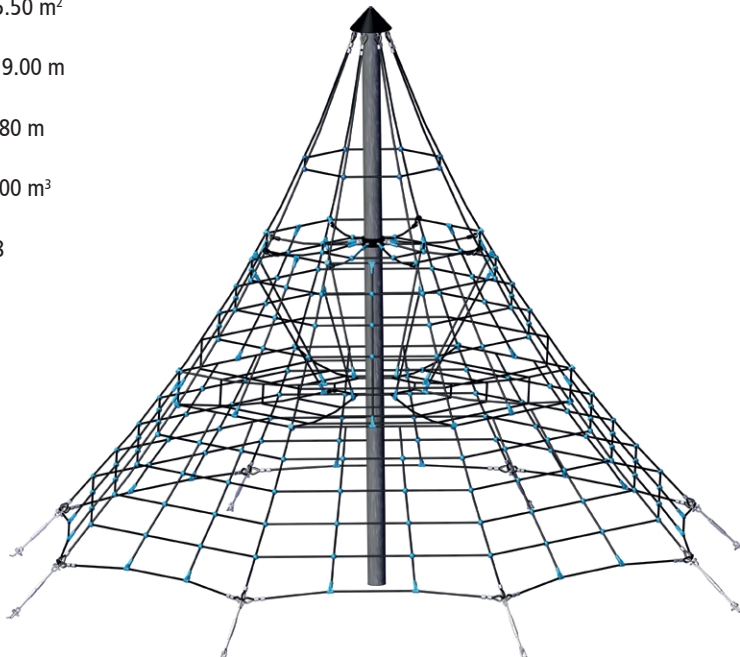

Ø 9.00 m

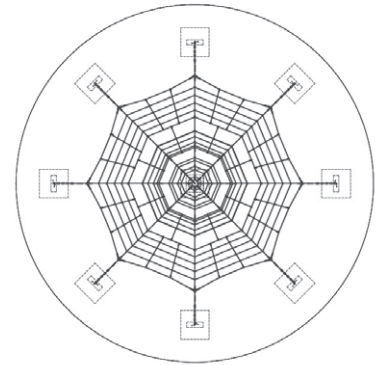

New look with black Hercules rope and blue plastic connectors.





JUMP UP!

Hally-Gally



TRAMPOLINES AND BOUNCER

Jumping makes you happy! Trampolines and bouncer are growing in popularity in playgrounds – no wonder then that children (and parents too) can properly let off steam here. In addition to pure enjoyment bouncing on a trampoline strengthens the muscular system, promotes balance and poise as well as dexterity and motor skills. With the trampolines and bouncer in the Hally Gally range you can enjoy the highest quality and safety in many different designs and for all requirements.

PRODUCT-HIGHLIGHTS



Trampoline "Rolli"
| 186 |

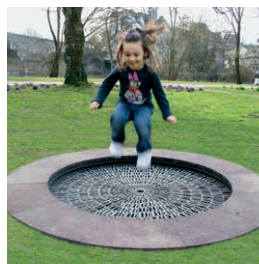

Trampolin "Circus"
| 188 |



Trampoline 2000 - The Original
| 194 |



Hally Gally Trampolines – according to DIN EN 1176

the original tried and tested a thousand times for twenty-five years now

Our robust trampolines that withstand any load are:

- ⊕ easy to install and maintain
- ⊕ available in various sizes and designs
- ⊕ completely pre-assembled and ready to play
- ⊕ alternatively, are available as a reasonably priced kit



The jumping mats used by us:

- ⊕ have specially created hot-dip galvanised steel springs
- ⊕ have an abrasion-proof jumping area
- ⊕ Made from either special environmentally friendly, soft, recycled rubber slats with woven inserts, plastic links or membranes (woven for strength, PAH free)
- ⊕ have tear-proof wire rope and offer a robust connection
- ⊕ provide the children with a soft and comfortable jumping experience



The spring suspensions used by us:

- ⊕ have specially created hot-dip galvanised steel springs
- ⊕ provide unchanged tensile strengths even after years
- ⊕ are distributed based on form and working load
- ⊕ are sound absorbing
- ⊕ facilitate soft jumping movements

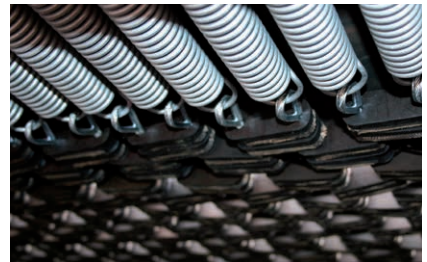

The fall protection plates used by us:

- ⊕ are hard-wearing and highly abrasion proof, especially at the edges
- ⊕ provide high quality shock absorption
- ⊕ Standard color red-brown, PAH-free, can also be supplied in black on request
- ⊕ are also available in other colours and in EPDM rubber upon request



The frame structures used by us:

- ⊕ have a complete steel sheet panel frame with reinforcement angles and extra-strong galvanising
- ⊕ are long-lasting and are suitable for permanent burial in moist ground
- ⊕ have a safe and secure hanging solution for steel spring device
- ⊕ have an ultra-strong abrasion protection on supporting areas under the frame
- ⊕ for years now have sound absorption elements between mats and frames

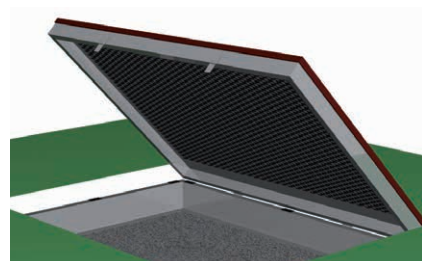

The dig-in frames used by us:

- ⊕ do not need to be set in concrete and multiple start-ups and setting times
- ⊕ form a sturdy and permanent connection with the trampoline

And the maintenance work?

- ⊕ Trampolines are low maintenance
- ⊕ Hanging hooks for trampoline mat included



Over-view of Hally-Gally trampolines

Hally Gally Trampolines – according to DIN EN 1176	Jumping area	External dimensions	Dig-in frames	Jumping mat material	Cleaning
Art. No. 20.02.115 "Rolli"	1.55 x 1.10 m	3.00 x 1.75 m	included	Plastic links	Mat can be hung up
Art. No. 20.02.122 Mini-Trampoline mounted	1.10 x 1.10 m	1.75 x 1.75 m	-	Rubber links	Mat can be hung up
Art. No. 20.02.126 Mini-Trampoline in ground	1.10 x 1.10 m	1.75 x 1.75 m	included	Rubber links	Mat can be hung up
Art. No. 20.02.112 "Circus"	Ø 1.30 m	Ø 1.90 m	included	Rubber links	Mat can be hung up
Art. No. 20.02.112G "Circus" with closed mat	Ø 1.30 m	Ø 1.90 m	included	Rubber mat	Mat can be hung up
Art. No. 20.06.104 "Circus Maximus"	Ø 1.90 m	Ø 2.50 m	included	Rubber mat	Mat can be hung up
Art. No. 20.02.106 "Maximus" 6.00 m long	0.98 x 5.34 m	1.65 x 6.00 m	included	Plastic links	Mat can be hung up
Art. No. 20.02.105 "Maximus" 9.00 m long	0.98 x 8.34 m	1.65 x 9.00 m	included	Plastic links	Mat can be hung up
Art. No. 20.02.118 "Piccolo" in ground	0.85 x 0.85 m	1.50 x 1.50 m	included	Rubber mat	Mat can be hung up
Art. No. 20.02.111 "Saturn"	1.00 x 2.00 m	1.50 x 2.50 m	included	Rubber mat	Can be lifted out
Art. No. 20.02.500 "Kangaroo"	3.85 x 0.85 m	4.50 x 1.50 m	included	Rubber mat	Mat can be hung up
Art. No. 20.02.120 "2000" mounted	1.75 x 2.50 m	2.25 x 3.00 m	-	Rubber links	Can be lifted out
Art. No. 20.02.125 "2000" in ground	1.75 x 2.50 m	2.25 x 3.00 m	On request	Rubber links	Folds out
Art. No. 20.02.110 XXL "2000"	1.75 x 3.00 m	2.25 x 3.50 m	-	Rubber links	Can be lifted out
Art. No. 20.02.108 "2012"	1.35 x 1.85 m	2.00 x 2.50 m	included	Plastic links	Mat can be hung up
Art. No. 20.02.102 "2014"	1.60 x 1.60 m	2.25 x 2.25 m	included	Plastic links	Mat can be hung up
Art. No. 20.02.121 "2017"	2.35 x 2.35 m	3.00 x 3.00 m	included	Plastic links	Mat can be hung up

Jumping equipment is not just jumping equipment

Bouncing on a trampoline – who doesn't like to do that. When designing our trampolines, we ensure that this enjoyment is not taken away from you and the jumping equipment meet the requirements of EN 1176. The design of jumping mats can have unpleasant impact on the user's well-being for example in their tension and thus jump frequency.

Therefore, in our jumping mat tension we proceed as follows: We set the tension essentially softer and gentler than is the case with many com-

parable pieces of equipment. In conjunction with the gradual elasticity our mats bounce lower, slower and overall softer - thus facilitating a noticeably more comfortable bounce. We therefore warmly recommend all trampoline lovers, not to dismiss these designs as unessential and to consider these when selecting a trampoline. So that bouncing on the trampoline remains a comfortable, pleasant and enjoyable experience in the long-term.



“Rolli” Trampoline - Wheelchair Friendly

Art. No. 20.02.115, incl. dig-in frames



For symbol explanation see folding card at the back

 3.00 x 1.75 m
Jumping area: 1.55 x 1.10 m

 32.40 m²

 6.35 x 5.10 m

 1.00 m

 3



Movement is a good thing –

even for those with disabilities. Therefore, we have developed the “Rolli” trampoline for wheelchair users.

BENEFITS

- ⊕ incl. 2 ramps inside for easy access!
- ⊕ easy clean, simply hang up the mat
- ⊕ quick assembly without concrete
- ⊕ pre-assembled ready to play







Mini-Trampoline

Art. No. 20.02.122, for setting up with high quality wooden cladding

Art. No. 20.02.126, in ground incl. dig-in frame



For symbol explanation see folding card at the back

-  1.75 x 1.75 m
Jumping area: 1.10 x 1.10 m
-  27.55 m²
-  4.10 x 4.10 m
-  Mounted 1.40 m
In ground 1.00 m
-  5
- 
- 

Benefits

- ⊕ Easy clean, simply hang up the mat
- ⊕ Quick assembly, no concrete
- ⊕ Assembled, ready to play
- ⊕ incl. dig-in frame



"Circus" Trampoline

Art. No. 20.02.112, incl. dig-in frames

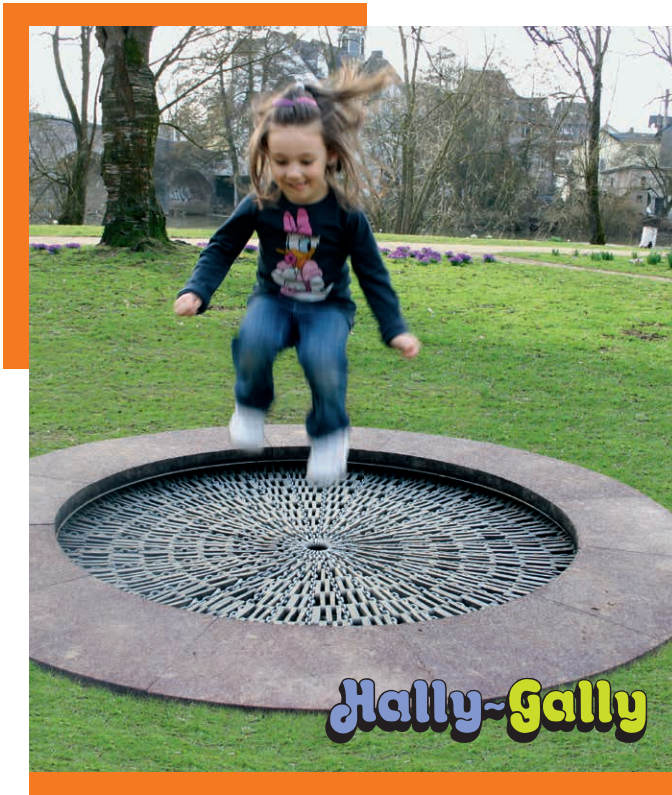







"Circus" Trampoline

with closed mat







Art. No. 20.02.112G, incl. dig-in frames



For symbol explanation see folding card at the back

-  Ø 1.90 m
Jumping area: Ø 1.30 m
-  14.85 m²
-  Ø 4.35 m
-  1.00 m
-  2
- 
- 

For symbol explanation see folding card at the back

-  Ø 1.90 m
Jumping area: Ø 1.30 m
-  14.85 m²
-  Ø 4.35 m
-  1.00 m
-  2
- 
- 

Benefits

- ⊕ Easy clean, simply hang up the mat
- ⊕ Quick assembly, no concrete
- ⊕ Assembled, ready to play
- ⊕ incl. dig-in frame









"Circus Maximus" Trampoline

Art. No. 20.06.104, incl. dig-in frames



For symbol explanation see folding card at the back

-  Ø 2.50 m
Jumping area: Ø 1.90 m
-  27.35 m²
-  Ø 5.90 m
-  1.00 m
-  3
- 
- 

Benefits

- ⊕ Easy clean, simply hang up the mat
- ⊕ Quick assembly, no concrete
- ⊕ Assembled, ready to play
- ⊕ incl. dig-in frame



"Maximus" Trampoline

Art. No. 20.02.106, 6.00 m long, incl. dig-in frames

Art. No. 20.02.105, 9.00 m long, incl. dig-in frames









Design with separate access ramp

For symbol explanation see folding card at the back





6.00 m long

Art. No. 20.02.106

-  6.00 x 1.65 m
Jumping area: 5.34 x 0.98 m
-  61.75 m²
-  9.35 x 5.00 m
-  1.00 m
-  8
- 
- 

9.00 m long

Art. No. 20.02.105

-  9.00 x 1.65 m
Jumping area: 8.34 x 0.98 m
-  61.75 m²
-  12.35 x 5.00 m
-  1.00 m
-  10
- 
- 

Benefits

- ⊕ Easy clean, simply hang up the mat
- ⊕ Quick assembly, no concrete
- ⊕ Assembled, ready to play
- ⊕ incl. dig-in frame









“Piccolo” Trampoline

Art. No. 20.02.118, incl. dig-in frames



For symbol explanation see folding card at the back

-  1.50 x 1.50 m
Jumping area: 0.85 x 0.85 m
-  14.05 m²
-  3.85 x 3.85 m
-  1.00 m
-  1
- 
- 

Benefits

- ⊕ Easy clean, simply hang up the mat
- ⊕ Quick assembly, no concrete
- ⊕ Assembled, ready to play
- ⊕ incl. dig-in frame









"Saturn" Trampoline

Art. No. 20.02.111, incl. dig-in frames



For symbol explanation see
folding card at the back

-  1.50 x 2.50 m
Jumping area: 2.00 x 1.00 m
-  30.00 m²
-  5.00 x 6.00 m
-  1.00 m
-  4
- 
- 

Benefits

- ⊕ incl. dig-in frames
- ⊕ quick assembly without concrete
- ⊕ pre-assembled ready to play









"Kangaroo" Trampoline

Art. No. 20.02.500, incl. dig-in frames



For symbol explanation see folding card at the back

	4.50 x 1.50 m Jumping area: 3.85 x 0.85 m
	38.10 m ²
	7.85 x 4.85 m
	1.00 m
	3
	
	

Benefits

- ⊕ Easy clean, simply hang up the mat
- ⊕ Quick assembly, no concrete
- ⊕ Assembled, ready to play
- ⊕ incl. dig-in frame



Trampoline 2000 – The Original

Art. No. 20.02.120, for mount with high-quality wood cladding

Art. No. 20.02.125, for installation





Art. No. 20.02.110 XXL



For symbol explanation see folding card at the back

Art. No. 20.02.120

Art. No. 20.02.125

-  3.00 x 2.25 m
Jumping area: 2.50 x 1.75 m
-  37.40 m²
-  6.50 x 5.75 m
-  1.00 m
-  8
- 

Art. No. 20.02.110 XXL

-  3.50 x 2.25 m
Jumping area: 3.00 x 1.75 m
-  40.25 m²
-  7.00 x 5.75 m
-  1.00 m
-  8
- 



Art. No. 20.02.120: Mounted version (Height approx. 45 cm) with high-quality impregnated and varnished wooden cladding.



Art. No. 20.02.120: version for assembly
Also available with a painted steel frame for an additional charge.

Dig-in frames Trampoline 2000

Art. No. 20.02.123

Art. No. 20.02.128 (for liquid fall protection)

Kit: Steel sheet frames for time-saving assembly without concrete work





Trampoline 2012

Art. No. 20.02.108, incl. dig-in frames



For symbol explanation see folding card at the back

-  2.50 x 2.00 m
Jumping area: 1.85 x 1.35 m
-  31.30 m²
-  5.85 x 5.35 m
-  1.00 m
-  4
- 
- 

Benefits

- ⊕ Quick assembly, no concrete
- ⊕ incl. dig-in frames
- ⊕ Easy clean, simply hang up the mat









Trampoline 2014

Art. No. 20.02.102, incl. dig-in frames



For symbol explanation see folding card at the back

-  2.25 x 2.25 m
Jumping area: 1.60 x 1.60 m
-  31.35 m²
-  5.60 x 5.60 m
-  1.00 m
-  4
- 
- 

Benefits

- ⊕ broken down for ease of shipping
- ⊕ for own set up on site
- ⊕ quick assembly without concrete
- ⊕ incl. dig-in frames
- ⊕ simple cleaning by hanging up mat









Trampoline 2017

Art. No. 20.02.121, incl. dig-in frames



For symbol explanation see folding card at the back

-  3.00 x 3.00 m
Jumping area: 2.35 x 2.35 m
-  40.30 m²
-  6.35 x 6.35 m
-  1.00 m
-  8
- 
- 

Benefits

- ⊕ Quick assembly, no concrete
- ⊕ incl. dig-in frames
- ⊕ Easy clean, simply hang up the mat

More colour options for safety pads and mats are available



FEEL HAPPY!



PLAYGROUND ACCESSORIES

Do your individual projects sometimes require individual accessories? Not a problem, on the following pages you will find our products which support the long-life cycle of your play equipment and the areas surrounding it. For this we have developed different detailed solutions, for example our sunshades and lawn protection mats.



Suspension bearings for swing seats

Page	Art. No.	Article description	Universal Joint Art. No. 4608 Page 201	Universal Joint incl. safety bearing Art. No. 4608-1 Page 201	Safety Bearing Art. No. 4608-5 Page 201	Swing Bearing Art. No. 4602 Page 202	Swing Bearing, reinforced version Art. No. 4608-3 Page 202	Bearing for Mini-M-Swing Art. No. 4602M Page 202	Bearing for Mini-M-Swing, robinia wood posts Art. No. 4602M-R Page 202	Swing Bearing with swivel rotating effect Art. No. 4608-4 Page 203	Swing Bearing with swivel rotating effect Art. No. 4608-2 Page 203
144	4650	Original HUCK Bird's Nest		x							
147	4650-85	Original HUCK Mini Bird's Nest		x							
147	4550	Original HUCK Honeycomb Nest		x							
147	4650-85M	Original HUCK Mini Bird's Nest for Mini-M-Swing						x	x		
149	4712	Safty Swing Seat with chain				x	x				
149	5720-1	Swing Seat with chain				x	x				
149	4700-08	Rustic Board Swing				x	x				
149	491	Pendulum Seat with chain								x	x
149	4698-1	Simple Tyre Swing				x	x				
149	4693-10	Baby Seat				x	x				
149	4693	Toddler Swing Seat				x	x				
149	4693-70	Double Toddler Swing				x	x				
150	4610	Climbing Chimney									x
150	4611	Climbing Chimney									x
150	4620	Rope Ring Swing Carousel									x
150	4630	Oval Rope Swing				x	x				
150	4695	Swing Seat Maxi					x				
150	4695-30	Swing Seat Midi					x				
150	4696	Swing Seat Mini					x				
151	4771-08	Partner Swing "Rustikal"				x	x				
151	4772-08	Trio Swing				x	x				
151	4585-40	Rope-end Swing		x							
151	4770-08-200/250	Jungle Rope Swing	x								
151	4651-20	Swing Bed		x							
152	806	Hammocks (with links and steel rope)								x	x
152	807	Hammocks Band								x	x
157	808	Hammock made from Hercules rope and knot balls								x	x
153	808VA	Hammock made from Hercules rope and knot clips								x	x
154	807-200	Hammock made from polyester								x	x
158	808-1	XXL Resting Hammocks								x	x

Universal Joint

incl. safety bearing for Bird's Nest swing

Art. No. 4608-1

Equipment

For hanging heavy suspended swings
(e.g. Original HUCK Bird's Nest)

With PA bearing and additional Teflon bush

Bolt - Universal Joint M18 x 220 mm,
Bolt - safety bearing M16 x 200 mm, red

With additional safety bearing and chain specifically
for hanging the Original HUCK Bird's Nest



Universal Joint for Bird's Nest swing

Art. No. 4608

Equipment

Bolts M18 x 200 mm, galvanized, red or black powder-coated

Bearing with polyamide bush and additional Teflon bush

Designed for both hook directions



Safety Bearing

with chain for Bird's Nest swing

Art. No. 4608-5

Equipment

Bolts M16 x 200 mm, galvanized, red or black powder-coated

Bearing with polyamide bush

Designed for one swing direction





Bearing for Mini-M-Swing

Art. No. 4602M

Art. No. 4602M-R, robinia wood posts

Equipment 4602M

Bolts M12 x 120 mm, galvanized, red powder-coated

With stainless steel shackle M8

Bearing with polyamide bush

Design for both swing directions

Equipment 4602M-R

Bolts M16 x 200 mm, galvanized, red powder-coated

With stainless steel shackle M8

Bearing with polyamide bush

Designed for both swinging directions



Swing Bearing reinforced version

Art. No. 4608-3

Equipment

Bolt M16 x 200 mm, galvanized, red

Bearing with polyamide bush

Designed for one swinging direction



Swing Bearing

Art. No. 4602

Equipment

Bolt M12 x 200 mm, galvanized

With PA socket with stainless steel shackle M8



Swing Bearing for Hammocks with swivel rotating effect

Art. No. 4608-4

Equipment

Bolts M16 x 200 mm, galvanized, red-powder-coated

With stainless steel shackle M8 and stainless-steel
swivel with fork head

Bearing with polyamide bush

Designed for both swinging directions



Shackle rotating swivel M8

Art. No. 4603 with Teflon bearing, stainless steel



Swing Bearing with swivel made of VA (ball bearings)

Art. No. 4608-2

to accommodate an 8 mm chain





Net and rope connectors for Robinia posts

Plates for chain coupling

including screws

Art. No. 4575-01-VA

Set to attach to post

Equipment

1 x stainless steel slotted disc (Ø 60 mm)

1 x stainless steel perforated disc (Ø 60 mm)

4 x pan head screw 5.50 x 19 mm

1 x button head screw 5.50 x 42 mm



Chain Shackle M8

incl. chain

Art. No. 4575-02-VA

set to attach to post

Equipment

1 x VA chain 6 mm, length 50 cm

1 x VA chain shackle M8 (Art. No. 440-30)



Further information on our Robinia posts can be found on Page 8

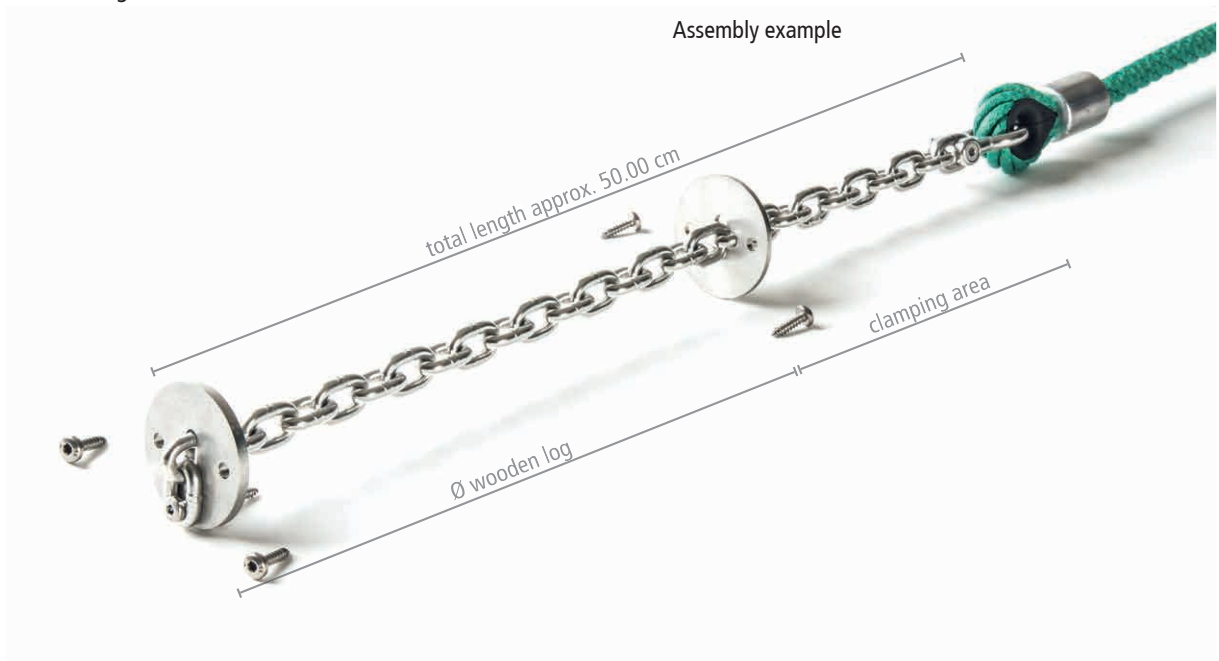



Maintenance and Repair Sets for Original HUCK Bird's Nests

Repair Kit for Bird's Nest base

Art. No. 4650-30

Equipment

1 unit PA-coated wire cable, 3/4.5 mm, 5 running metres

30 units plastic links (20 units wide, 10 units. narrow)

10 units high-alloyed screw connector

20 units raised head with Torx and safety pin M5 x 10 mm

1 manual



Repair Kit for Bird's Nest rope wrapping

Art. No. 4650-31

Equipment

1 unit shrink ring, black width 50 mm –
0.4 running metres - incl. adhesive patch

1 roll of adhesive patch, 50 mm wide,
white approx. 1.5 running metres

2 units hose clip (Ø 90 - 110 mm)

1 unit foam film

1 manual



Suspension Chain Set for Bird's Nest Swing

Art. No. 4650-20

Equipment

With chain sleeve

Hose colour: red or black

universal for suspension level of 2.00 m to 2.60 m



Suspension Ropes for Bird's Nest Swing

Art. No. 4650-10

Equipment

Rope colors: black, fluorescent orange, hemp-colored, grey, red,
fuchsia, blue, yellow, green, turquoise, rust

universal for suspension level 2.00 m to 2.60 m



Our Original Huck Bird's Nest
can be found on Page 144





Sport, play and leisure-time

Football Goal "Goalie"

Art. No. 4666-130 Mesh size 13 x 13 cm

Art. No. 4666-130-K Mesh size 13 x 13 cm, with 2 goal baskets

Art. No. 4666-230 Mesh size 23 x 23 cm

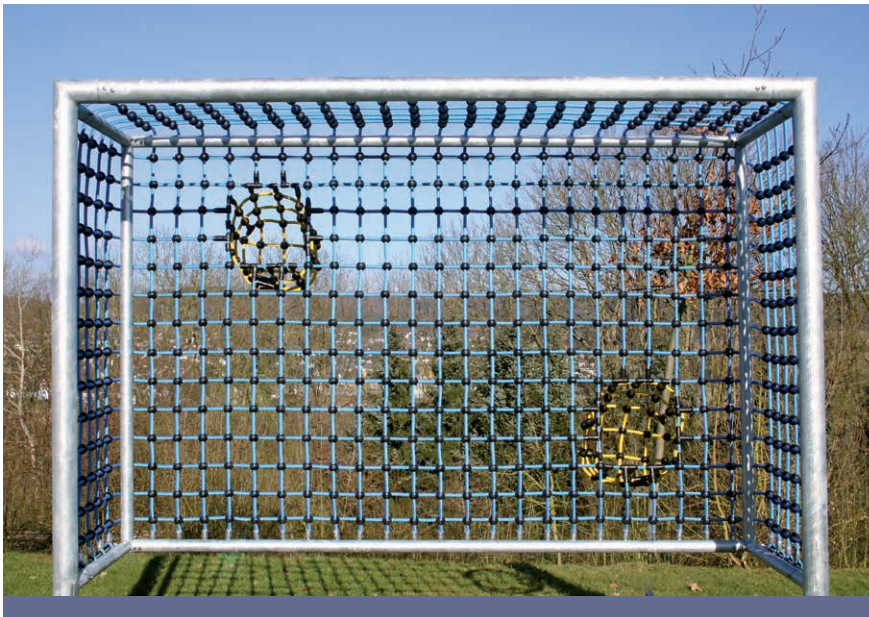

Equipment

Steel goal frames (Ø 102/76 mm), hot-dip galvanized, to be set in concrete

2 ground anchor screws for a stability for concreting in

Net made from Hercules rope (Ø 16 mm, 6-strand, with steel core), Colour: 04 blue

2 goal wall baskets (60 x 60 cm) made from Hercules rope (Ø 16 mm, 6-strand, with steel core), Colour: 05 yellow

Technical data

Length: 3.20 m

Depth: 1.00 m

Height: 2.15 m



Tested according to DIN EN 15312

A strong goal: Our HUCK football area goals – designed for football and handball – withstand maximum stress. We therefore provide you with a 15-year guarantee for the steel frame. We also offer a price-conscious option with bigger mesh-size.

Simply speak to us!

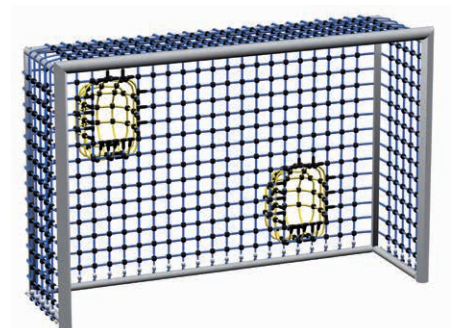

On request, special version available too in other net sizes – 2.00 x 1.50 m (length x height), depth 0.90 m

Football Goal "Goalie Sport"

Art. No. 4665



Equipment

Steel goal frame (Ø 102/76 mm), hot-dip galvanized, for a surcharge also available painted

2 ground anchor screws for a stability for concreting in

Net made from Hercules rope (Ø 8 mm, 3-strand with steel core), Colour: black

HUCK knot system, colour: black

Technical data

Length: 3.20 m

Depth: 1.00 m

Height: 2.15 m



Tested according to DIN EN 15312

Freely accessible
multi-sports equipment

The "Goalie Sport" frame is identical to the "Goalie" frame:

STRONG – STURDY – DURABLE

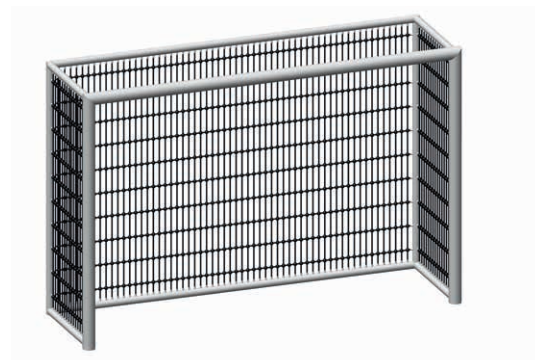



Football Goal Net "Dralo"

Art. No. 4064



Equipment

Steel wire rope (Ø 3 mm), galvanized

Mesh size approx. 10 cm, square mesh design

Incl. anti-theft rope assembly kit

Goal frame not included!

Technical data

Length: 3.00 m

Depth: top 0.90 m, bottom 0.90 m

Height: 2.00 m



Tested according to DIN EN 15312

Football Goal Net "Clips-Version"

Art. No. 4664

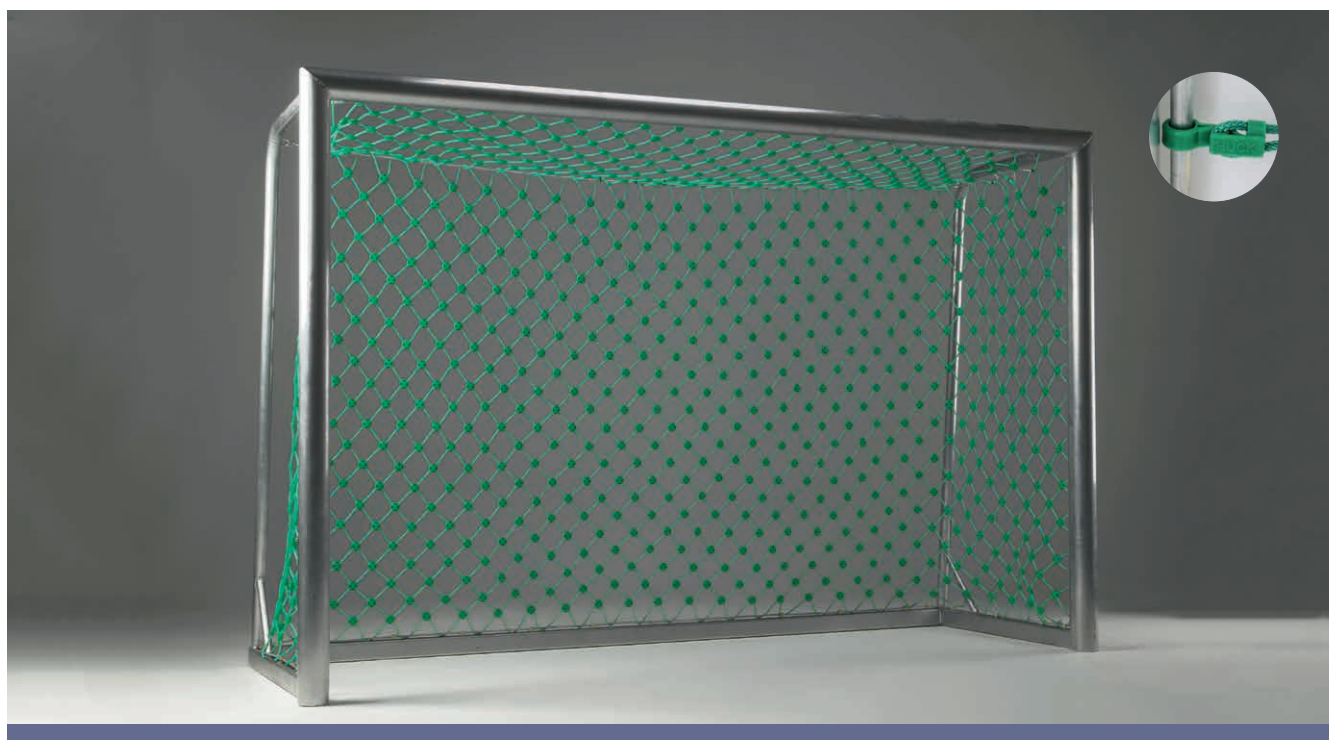

Equipment

Clip net made of Hercules rope (PES-coated, Ø 5 mm), suitable for handball goals

with net hoop mesh size 10 cm, diagonal stitches, green, black, beige

Goal frame not included!

Technical data

Length: 3.00 m

Depth: 0.90 m

Height: 2.00 m



Tested according to DIN EN 15312

SIGNIFICANTLY IMPROVED!

With additional scoring protection in the outer area made from high-quality polyamide loops!

ASSEMBLY INSTRUCTIONS

Always hang the goal net inside the goal frame.
Never pull the net over the frame!

⊕ Rope design: PES-coated, green, black or beige

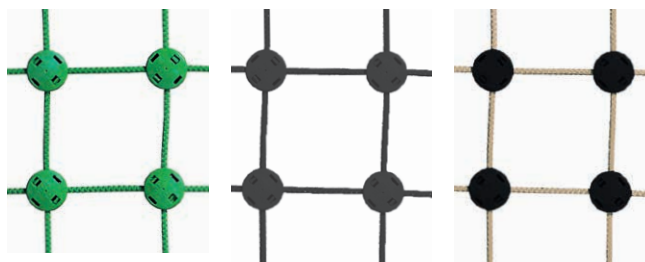



Ball stop fence nets

Multi-functional play facilities have an important social function in residential areas. They are a place where young people can be active together in a sporty way without the fear of smashing a windowpane or suchlike. Equipped with anti-vandal sport nets these facilities offer high quality with long service, plus increasing the living quality of residents.

When used as an anti-vandal ball stop net the HUCK clips net made from Hercules rope achieve better sound-proofing properties than a mesh wire or steel grating fence measured in accordance with DIN EN ISO 11202.

Hercules-Clips net

The 2,50 mm polyester coated wire rope is connected to a square mesh net using a plastic knot connecting system. The coating provides for a durable and attractive surface.

Dralo wire rope net

Dralo is the wire rope net in the HUCK range with a decent design, which despite this can only be destroyed with extreme force. At the same time the rope net emanates less noise upon ball contact.

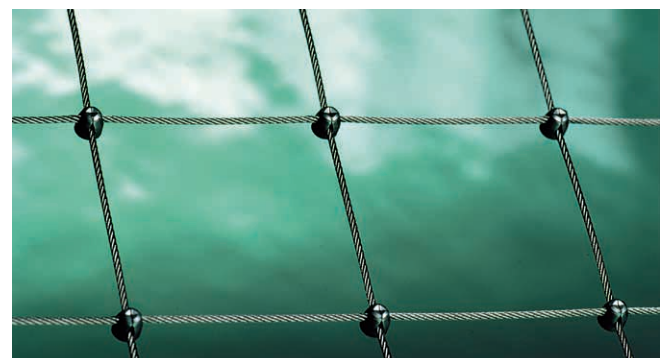
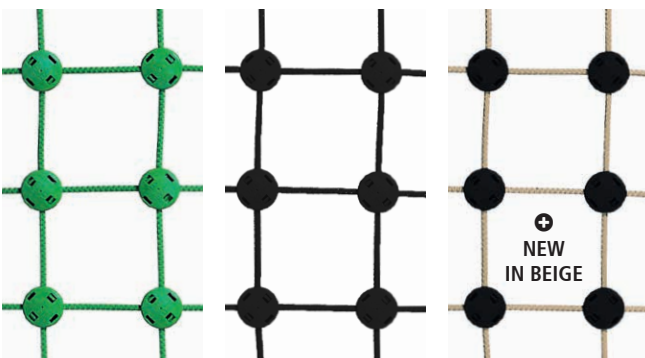

- ⊕ Rope design: PES-coated, green, black or beige
- ⊕ Rope thickness: 5 mm (Wire strand 2.5 mm Ø)
- ⊕ Mesh size: 50, 100 mm (rhombic)
- ⊕ Knot connection: plastic clips (green or black)
- ⊕ Mesh strength: approx. 0.5 kN
- ⊕ Vandal-proof level: average

- ⊕ Rope design: galvanized or stainless steel
- ⊕ Rope thickness: 1.5 mm bis 5.00 mm
- ⊕ Mesh size: 25 to 200, 50 x 100, 50 x 200 mm
- ⊕ Knot connection: Aluminium or stainless-steel clips
- ⊕ Mesh strength: approx. 0.8 – 3.5 kN
- ⊕ Vandal-proof level: high



HUCK Dralo Ball stop fence modular system

The silent ball stop net

Our basic module has a standard width and height of 5 metres each, but this can be quite simply made bigger with other modules (also 5 x 5 metres in size).

The basic module includes two posts, a net incl. crossbar for the top closure, the necessary tensioning piece and assembly accessories. If you order additional modules, we supply another post, the net and all necessary small components.

The tension puller developed especially for this module system (top) facilitates a light cross-profile for maximal stability. This then creates a visually pleasing, straight finish to the wire rope net.

The assembly of the net fields (net + crossbar) can be easily managed by one person in a mobile elevating platform. The system can be efficiently assembled and contains durable, vandal-proof components.

With the formation of different mesh sizes (below 50 x 100 mm, from 2 m height, 50 x 200 mm climbing the fence is supposed to be prevented at the same time as saving weight. Pursuant to DIN EN 15312 the horizontal mesh size of ball stop nets must not exceed 50 mm, to make it difficult to climb.

Ball Stop Fence "Dralo" basic module

Art. No. 46500 Width: 5.00 m, Height: 5.00 m

Equipment

2 Posts (1x 6.00 m, 1x 6.50 m)

1 Dralo Net (5.00 x 5.00 m) incl. crossbar

Tensioning rope

Fastening accessories



Ball Stop Fence "Dralo" add-on module

Art. No. 46500-1 Width: 5.00 m, Height: 5.00 m

Equipment

1 Post 6.00 m or 6.50 m

(6.00 und 6.50 m can always be alternated)

Fastening accessories

Ball Stop Fence "Dralo" 90° corner module

Art. No. 46500-2

Equipment

90° angle

⊕ SILENT BALL STOP NET

because of strong connection of the net knots

⊕ VANDAL PROOF

With the use of a steel rope net

⊕ EASY ASSEMBLY

Due to handy module size

Net height from 2.00 m
mesh size 50 x 200 mm.
This low-cost mesh size is perfectly sufficient for balls.

For net heights up to 2.00 m
mesh size 50 x 100 mm.
This mesh size is difficult to climb.

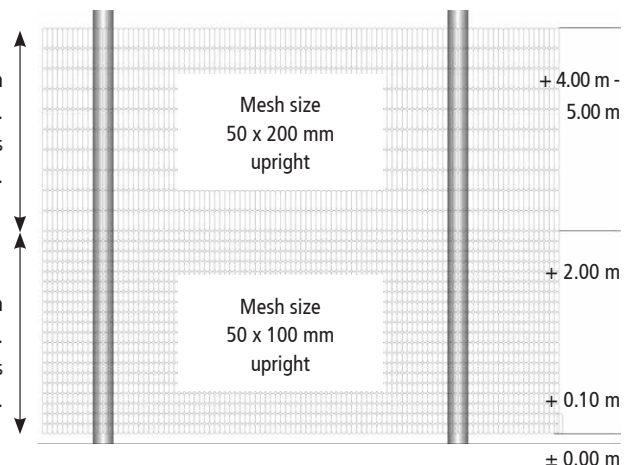



Basketball "Hercules-Clips-Net" single

Art. No. 4677-2 – Rope green/Clips green
 Art. No. 4677-2-06 – Rope black/Clips black
 Art. No. 4677-2-C01S06 – Rope black/Clips green
 Art. No. 4677-2-C06S08 – Rope cream/Clips black



ANTI-THEFT PROTECTION!

For end fastening the clamps are pushed up the whole way and closed. This secures the net and protects it from theft!

1000 TIMES PROVEN!

Equipment

Clip net made of Hercules rope (PES-coated, Ø 5 mm, with steel core) suitable for every standard basket available on the market (not available from HUCK), theft-proof assembly thanks to integrated clamps

Noise reduction compared to chains



Art. No. 4677-2
Rope green/
Clips green



Art. No. 4677-2-06
Rope black/
Clips black

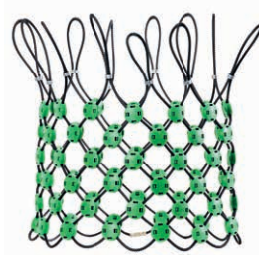

Art. No. 4677-2-C01S06
Rope black/
Clips green



Art. No. 4677-2-C06S08
Rope cream/
Clips black

Volleyball Net "Hercules-Clips-Net"

Art. No. 4674-1 without posts (available as an option)

Equipment

(Ø ca. 2.5/5 mm) Mesh size 100 mm

Net size 1.00 x 9.50 m (international provision), Colour green

Volleyball Net in "Dralo"

Art. No. 4674-10 without posts (available as an option)

Equipment

Steel wire rope (Dralo) (Ø 2 mm), galvanized, mesh size 100 mm

Net size 1.00 x 9.50 m (international provision)

Edging made from 160 mm wide coated fabric with "HUCK" printing

For use with standard volleyball posts



The tear-proof volleyball net in attractive design – fits all standard volleyball posts.





Sun sails



Possible shapes



For special shapes and larger sails, we recommend the sun sail material with a shade of 90:10 (320g/m²). Please contact us for professional advice!

Shade 50:50 (200g/m²):

orange, blue, red, light green, dark green, silver, terracotta, cream

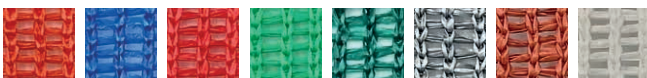

Shade 90:10 (320g/m²):

blue, dark green, silver, cream

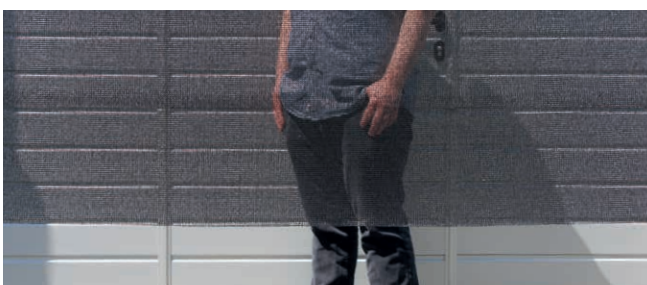



Sun Pavilion Cover Combination

Art. No. 5782-1-04 without ground sleeves

Art. No. 5782-2-04 with ground sleeves



Equipment

Awning made from water-permeable and breathable fabric (blue, other colours on request)

Incl. hot-dipped galvanized steel pipes (Ø 76 mm)

With lashing strap for height adjustment

Shade 50:50

Available with or without ground sleeves

Technical data

Size: 5.50 x 5.50 m

Necessary basic measurements:
6.90 x 6.90 m

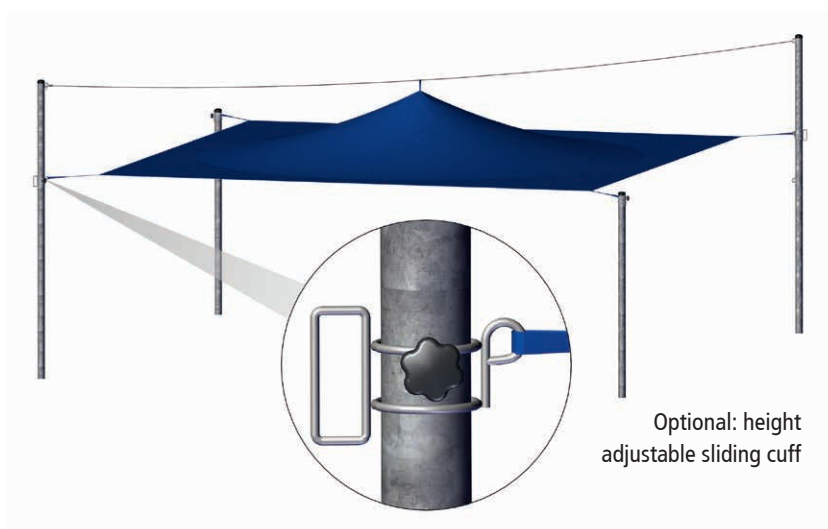

Slip-on Sleeve (stainless steel)

Art. No. 5785 one unit per post

Equipment

With handle opening and eyelets

Steel thickness 8 mm,
for 76 mm Ø – Steel posts



SIMPLY CLEVER!

Suitable for posts Ø 76 mm in diameter, the slip-on sleeves can be adjusted to any height and automatically fixed through the anchor. Create a simple connection between posts and sail.

Not suitable for powder-coated or painted posts

Tension Belt

Art. No. 5502-025

orange, cream, black,
silver, red, blue, dark green





Sandpit Cover

Art. No. 720, Size as requested



Equipment

Air and water permeable synthetic fabric, UV resistant cover colours blue, red, light green, dark green, orange, silver, terracotta, cream

With reinforced edges and cover eyelets
(Distance 0.50 m between each one)



Rubber Edging Cord

Art. No. 2126

Equipment

Ø 6 mm, white with identification stripe

Recommended fastening: PE buttons Art. No. 720-1

NO CONTAMINATION

➔ animal excrement, foliage, falling leaves

ORDER WITHOUT OVERHANG
Please specify sandpit dimensions.

ORDER WITH OVERHANG
Please specify desired final measurements of the cover/net.
Usually an overhang of 20 cm on each side.



PE Buttons

Art. No. 720-1 Set of 10

Equipment

With stainless steel screws and distance sleeves to hang the rubber edging cord

Recommendation: spaced every 60 cm





Lawn Protection Mats

20 years of experience speaks for itself

As soon as play area grass is frequently used, it gets worn away from time to time. It can be that stones protrude, which increase the risk of an accident for children. When it is wet, they slip over and when it is dry the impact is no longer gentle but instead quite painful. Neither does the grass grow back quickly at these spots.

That's why we recommend our lawn protection mats to you. They protect meadows and children alike. The mats almost come part of the ground and can also be placed down subsequently without any problems. Moreover, a gentler fall for children and they are not so quick to slip over. With these beneficial properties our lawn protection mats mean that children can let off steam in any weather.



Mats approx. 4-5 weeks after assembly



Lawn Protection Screen Mats

Art. No. 4656

Description

Plastic-coated, close-meshed chain-link mats, abrasion proof, UV resistant, can be mowed over

Thickness approx. 2 mm, fixed width 5.00 m (Roll goods), can be cut to any size, larger areas can be made bigger if required

Colour: 06 black

Easy assembly by burying in the boundary area

IN USE FOR 20 YEARS

Low-cost protection in closed facilities

- ⊕ non-slip
- ⊕ easy to assemble

Lawn Protection Mats for swingers

Art. No. 4655

Description

Heavy duty, elastic rubber chain-link mat, can be mowed over, firm, very robust

Thickness approx. 20 mm, size 0.90 x 1.50 m

Colour: 06 black

For simple, strong, dig-in anchorage

IN USE FOR 20 YEARS

Vandal-proof option

- ⊕ non-slip
- ⊕ very robust
- ⊕ easy to assemble





Slope stabilisation roll chain-link mats

The solution for hills that are played on:

Do you know that costly steps are built next to hillside slopes of less than - 1.00 m, which often go unused. Instead the climb directly next to the slide is used and worn away by children playing.

Protect the ground and slopes in strongly used areas (e.g. directly next to slides) in a sustainable and inexpensive way! Our roll chain-link mat is exactly the right thing for you here!

We produce these from the rubber elements from our Hally-Gally trampoline range, which have been tried and tested for 30 years now. They adapt to the terrain, are flexible, cushion falls and can be fixed into the ground with anchor chains.

Cover the mats evenly with mulch or sow grass – playtime does not even have to be interrupted for this. Neither are washed or worn away during play.

HAVE A QUOTE DRAWN UP!

- ⊕ any length
- ⊕ any width, up to max 2.00 m per segment
- ⊕ "joining" possible
- ⊕ segments possible

YOUR BENEFITS

- ⊕ cost efficient
- ⊕ quick to assemble
- ⊕ non-slip
- ⊕ no wearing away effect through play
- ⊕ Segments possible
- ⊕ with pre-mounted anchor chains

Explanatory notes on the tested drop heights Relating to lawn protection mats and roll chain-link mats

- ➔ Our lawn protection mat was tested according to DIN EN 1177 according to international laboratory conditions and has theoretically approval for a fall height of 70 cm for use on concrete floors.
- ➔ In addition, testing was carried out on site on a grass area in accordance with DIN EN 1177 Para. 4.7.3. The drop height ascertained here exceeded the values of the test on concrete by a lot as expected.
- ➔ In theory a value of only around 377 HIC was determined for a maximal drop height on grass (1.50 m).
- ➔ Maximum allowed would be 1000 HIC.



Mat directly after placing



Small hole in ground for anchor chains + point foundation (ca. Ø 5.00 cm)



Lawn protection mats after installation (laid open for photo)





Bollards

For the natural boundary of water areas, pathways, meadows etc. Quick and low-cost assembly. PP rope is only destructible using extreme force thanks to its steel wire. The "hemp" colour is harmonious in urban design. The recommended spacing between posts is 2.50 m to 3.00 m.

The rope is pulled through the posts on site for the entire length required. To prevent the rope from slipping, it is then fixed to each post using an internal sleeve.



PP-Rope with steel core
per running metre Art. No. 4990-08

Description

Ø 65 mm

With steel core (Ø 10 mm)

Rope colour: hemp coloured



Fixing Sleeves

Art. No. 4990-10

Description

For attaching on the inside

Please note: 2 sleeves are required for end bollards!



Middle Bollard with 1 drill hole

Art. No. 4990-4-10

Description

Sanded Douglas fir posts, core separated, pressure-treated

Ø 16 cm, length 1.50 m, without fixing bushes



End Bollard with 2 drill holes

Art. No. 4990-5-10

Description

Sanded Douglas fir posts, core separated, pressure-treated

Ø 16 cm, length 1.50 m, without fixing bushes



WELL DONE!





REFERENCES

Whenever the large variety of our HUCK catalogue is just not enough, we can realise individual solutions customised for your project and its specific requirements, thus offering you a tailormade service! On the following pages you will find individual customer solutions which we have designed, produced and assembled. Using our know-how and our many years of experience in designing play rope equipment we create the perfect experience for your indoor or outdoor projects. Because we know what matters.





A playground in white inspires not just kids



Moulins, France
Partner: HUCK Occitania S.A. | PRO URBA | ©Thierry Demko

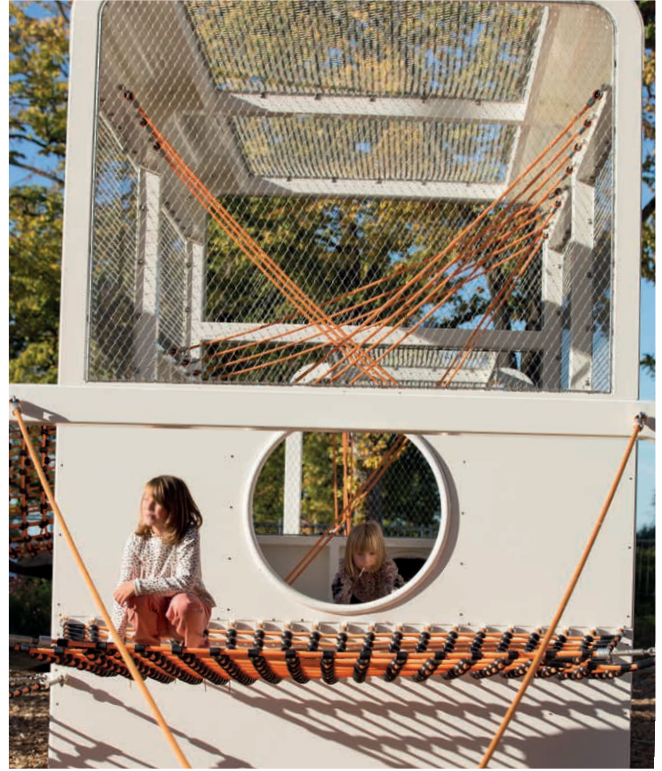

Happy children and parents at the mall „Shopping Promenade cœur Alsace“



Mundolsheim, Alsace, France
Partner: HUCK Occitania S.A. | PRO URBA | ©Geneviève Engel





City park with a difference – movement in the tunnel

Girondins Development Area Base, Lyon, France
Partner: HUCK Occitania S.A. | PRO URBA | ©Thierry Demko

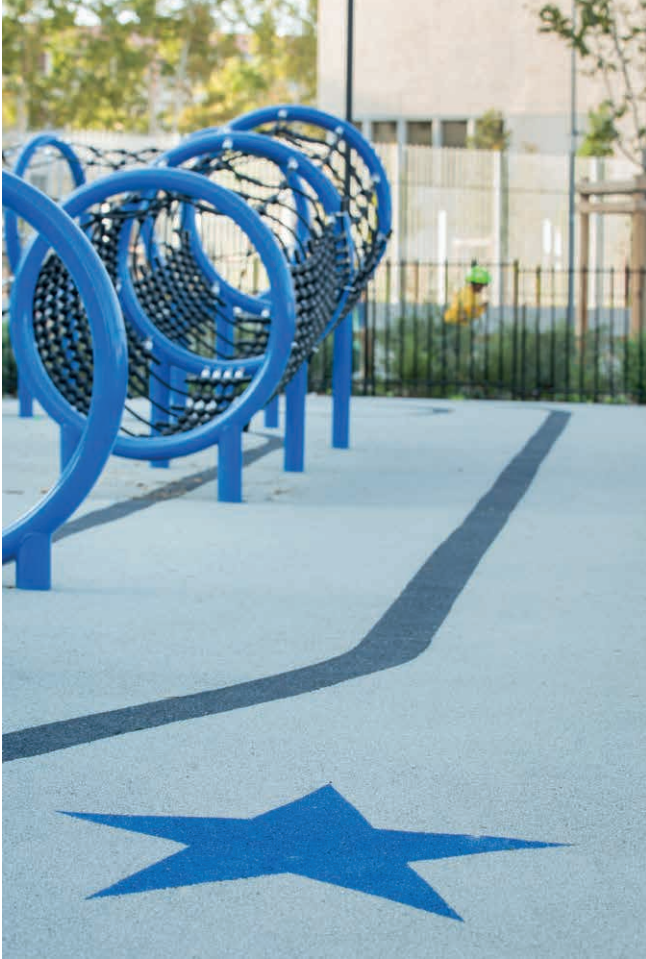

High Up Down Under



Manor Lakes, Australia
Partner: Playground Centre New Zealand





The Black Forest Bird's Nest Tower on the other side of the world

South New Brighton Domain Christchurch, New Zealand
Partner: Playground Centre New Zealand



Limitless Combination: Bird's Nest Tree meets Pirate Tower

Perth, City of Belmont, Australia
Partner: Playground Centre New Zealand





Climb, discover and hide at Centerparcs Het Heijderbos

Heijen, Netherlands
Partner: HUCK Torimex BV



Rest and Play in the zoo in Amersfoort

Amersfoort, Netherlands
Partner: HUCK Torimex BV





Playground in the furniture store IKEA – Let off steam as you please

Faro, Portugal
Partner: Playparc GmbH

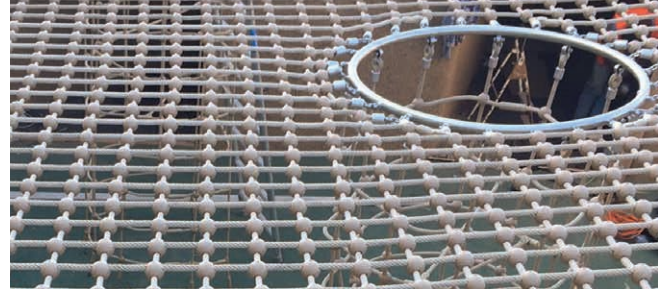

Swinging in the treetops in City Park Klatovy

Klatovy, Czech Republic
Partner: Berger-HUCK s.r.o.

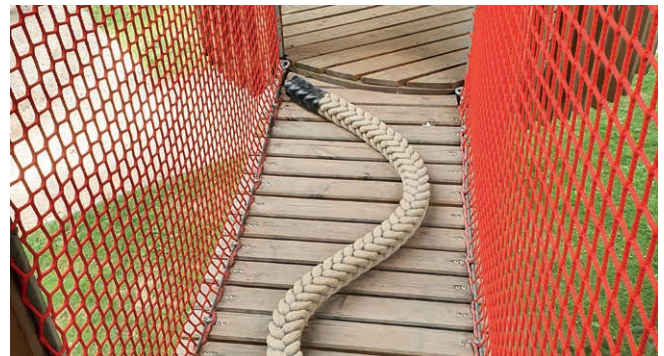



Unique Net Landscape in the hotel Downtown Camper by Scandic

Stockholm, Sweden
Partner: ScanCord AB

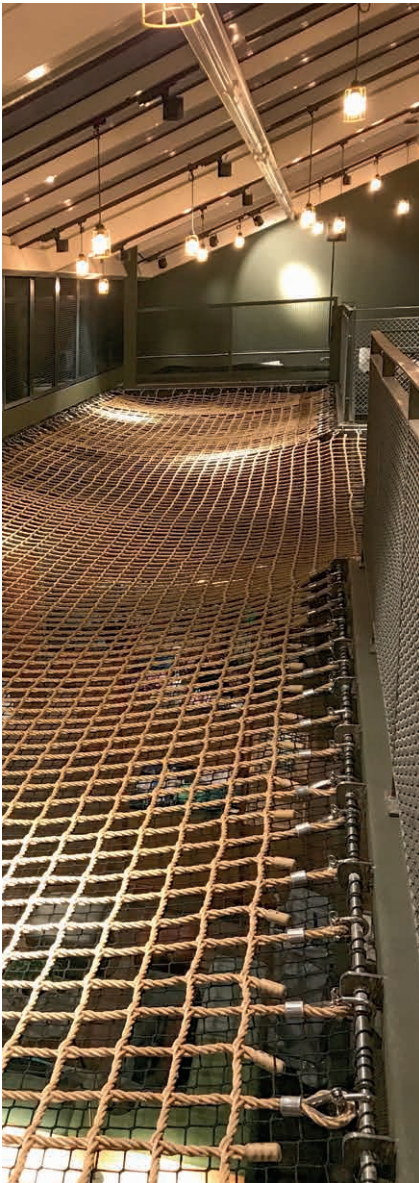

Bird's Nest Tower combination: "Black Forest" also in Scandinavia



Eskilstuna, Sweden
Partner: ScanCord AB





Rope course and net landscape adventure for young and old



Biala, Poland
Partner: HUCK Polska Sp.z.o.o.



Various playground equipment with lots of climbing fun



Cuarte de Huerva, Pamplona and Gelsa, Spain
Partner: HUCK SPAIN





Climb up a pyramid or navigate a tunnel?
Anything is possible



Konya, Turkey
Partner: Turkuaz Park



Our Bird's Nest Tower "Black Forest" combination allows for fun in every country



Ankara, Turkey
Partner: Turkuaz Park





“Somewhere Over The Rainbow” Net tunnel in the Walibi adventure park

Wavre, Belgium
Partner: Huck N.V. | A & P



Experience underwater worlds and work out in the Net – Sealife with a difference



Blankenberge, Belgium
Partner: Huck N.V. | A & P





Net tunnel with wooden walkway in Västra Hamnen city park

Malmö, Sweden
Partner: ScanCord AB

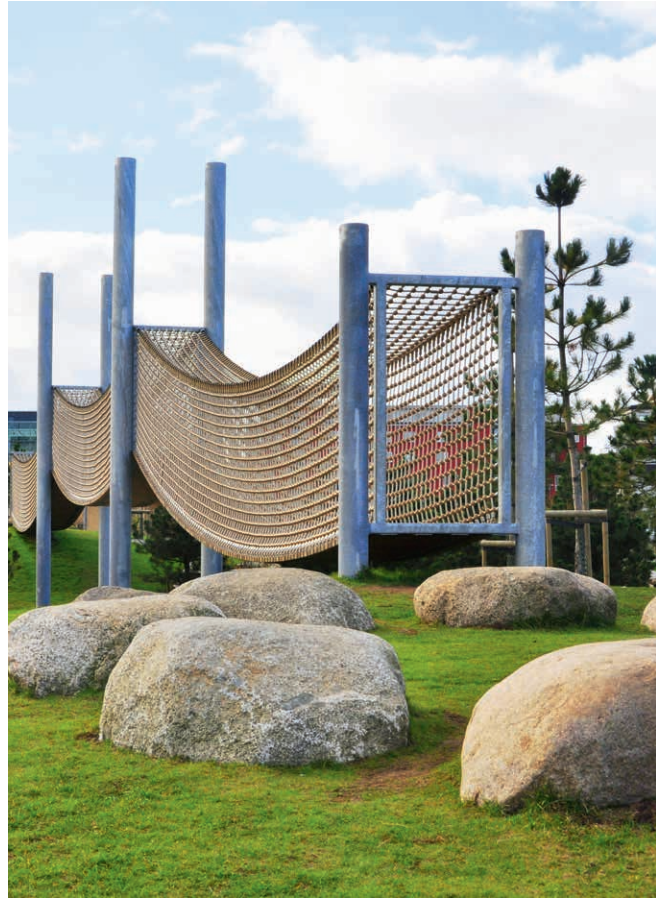
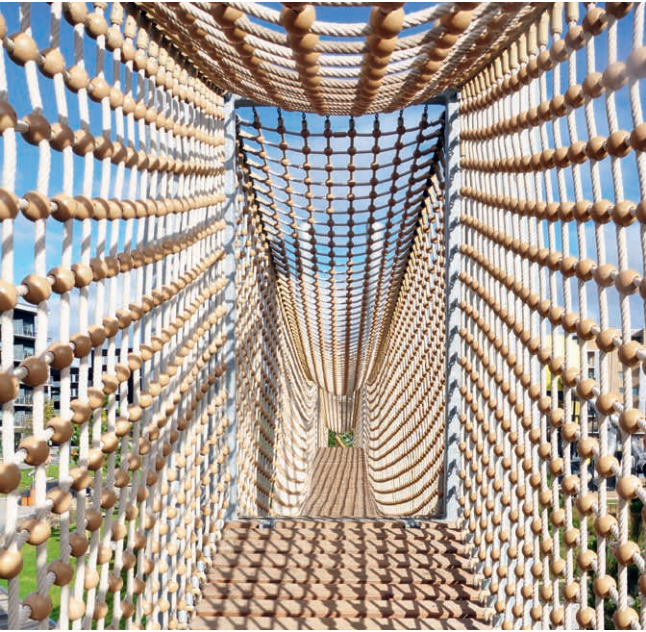

Gigantic adventure: tree top pat, 32 m high made with small-mesh surface net

Bachledka, Slovakia
Partner: Immobau s.r.l.





Playtime on the Hercules rope: The orangutang is loose in Tiergarten Schönbrunn



Vienna, Austria
Partner: Berger GmbH

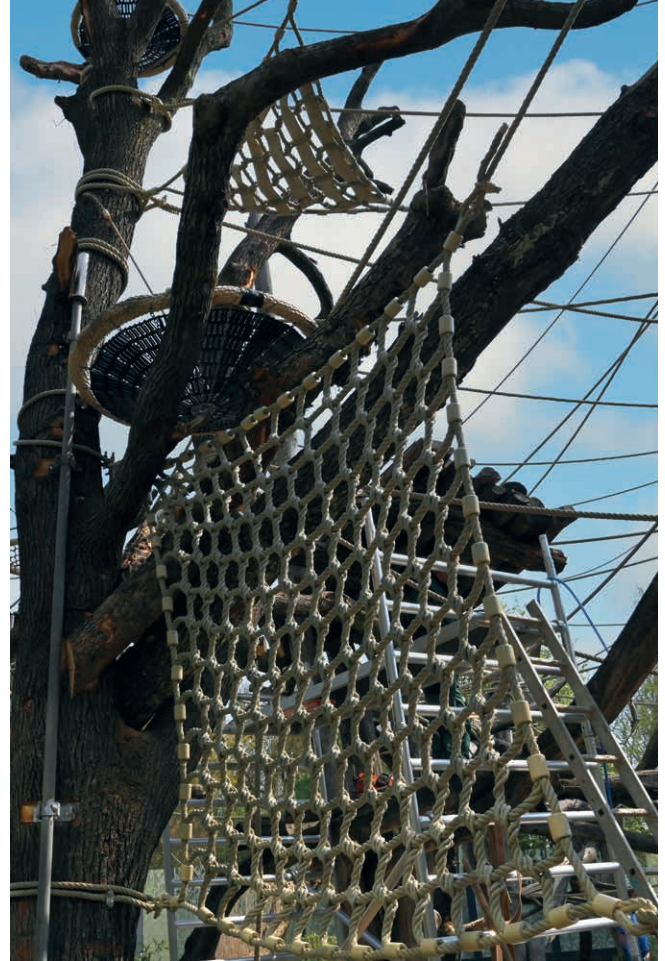

Go full throttle in parcours and pyramids – Hanging out in the chill-out bird’s nest



Colchester, USA
Partner: NetPlay USA LLC





Climbing fun in the Winners Dome: the largest indoor playscape in Germany



Winnenden, Germany
Partner: Benz Sport



List of keywords

2-eye shackle stainless steel	126		
3-eye shackle stainless steel	126		
A			
Adventure Honeycomb Nest	28		
Aerial Runway - concrete-in version	84		
Anaconda Maxi	54		
Arch Steel Frame for XXL Hammock	156		
Arch Swing	137		
B			
Baby Seat	149		
Ball Stop Fence "Dralo"	211		
Band Hammock.....	152		
Basketball "Hercules-Clips-Net"	212		
Bearing connector stainless steel	125		
Bearing connector.....	125		
Bearing for Mini-M-Swing.....	202		
Bird's Nest "Chill Out" XXL	159		
Bird's Nest Carousel.....	46		
Bird's Nest Tower "Black Forest"	98		
Bird's Nest Tower "Black Forest"-Combi....	95		
Bird's Nest Tower	97		
Bird's Nest Tree "Drago"	88		
Bird's Nest Tree "Laola"	91		
Bird's Nest Tree Midi.....	94		
Bird's Nest Tree with bridge and slide	92		
Bird's Nest Tree, steel cossbeams	89		
Bird's Nest Tree, wood crossbeams.....	89		
"Black Beard" Pirate Ship.....	80		
Bow Net.....	70		
C			
Chain adapter M12 for 6 mm chain	125		
Chain adapter M16 for 8 mm chain	125		
Chain pressed-in, 6 mm galvanized	124		
Chain shackle for 6 mm & 8 mm chain	124		
Chain shackle M6, quadruple connection .	125		
Chain shackle M6, triple connection.....	125		
Chain Shackle M8 incl. chain	204		
Chain with plastic adapter	124		
Cheops-Combination Midi	169		
Cheops-Pyramid Maxi	167		
Cheops-Pyramid Midi.....	168		
Cheops-Pyramid Mini.....	170		
Climb and Chill	74		
Climbing Bench.....	38		
Climbing Chimney with ground anchor	150		
Climbing Chimney without ground anchor	150		
Climbing Equipment "Colour mix"	37		
Climbing Glasses.....	73		
Climbing Palm	75		
Climbing Whirl	76		
Cyclops Swinger, 4-seater, single.....	104		
D			
Deep Space Pyramid	181		
Diablo	44		
"Dillenburg" Climbing Net	111		
"Dillenburg" Hanging Rope	111		
"Dillenburg" Rubber Hammock	111		
"Dillenburg" Wobble Beam	111		
Double Toddler Swing	149		
Douglas fir posts for Hammocks	152		
Dragon Swinger	101		
E			
Eagles Nest Platform.....	62		
Eagles Nest Tree, steel crossbeams.....	90		
Eagles Nest Tree, wood crossbeams	90		
Earthworm Mini.....	55		
Easy-Climb 1	34		
Easy-Climb 4	35		
Easy-Swing "Honeycomb Nest".....	141		
Easy-Swing "Maxi".....	142		
Easy-Swing "Midi"	142		
Easy-Swing "Swing Bed"	142		
Ellipsisilon	68		
End Bollard with 2 drill holes	219		
F			
Fixing Sleeves	219		
Floating Mats.....	52		
Football Goal "Goalie Sport"	207		
Football Goal Net "Clips-Version"	209		
Football Goal Net "Dralo"	208		
"Fortuna" Bird's Nest Tower	18		
"Fortuna" Mini Pirate Tower	14		
"Fortuna" Play Course	23		
"Fun cours" 3-part Ladder	114		
"Fun cours" Adventure Tunnel	114		
"Fun cours" Arc Bridge	114		
"Fun cours" Bridge	114		
"Fun cours" Loop Bridge for wood posts .	114		
"Fun cours" Small Discs	114		
"Fun cours" Steel posts, single	115		
G			
Garland rope.....	128		
Gondolar Swinger	103		
Green Mamba.....	55		
Ground anchor (screwable)	129		
H			
"Haiger" Arc Rope	110		
"Haiger" Balancing Rope	110		
"Haiger" Bar for steel post, single	110		
"Haiger" Climbing Net	110		
"Haiger" Climbing Rungs	110		
"Haiger" Hanging Rope	110		
"Haiger" Inclusion Equipment.....	13		
"Haiger" Holding Loops	110		
"Haiger" Holding Rings	111		
"Haiger" Polyester Hammock	111		
"Haiger" Robinia wood posts, single	115		
"Haiger" Rope Ladder	110		
"Haiger" Rope Ladder Rungs	110		
"Haiger" Rubber Hammock	111		
"Haiger" Small Disc	110		
"Haiger" Steel posts, single	115		
"Haiger" Surfer	110		
"Haiger" Swing Seats	110		
"Haiger" Tyres	111		
"Haiger" Wobble Beam	111		
Hammock Trio.....	155		
Hercules Climbing rope.....	127		
Hercules Rope Hammock	153/157		
Hercules-Climbing Nets, Ø 16 mm	122		
Hercules-Climbing Nets, Ø 18 mm,	122		
Hercules-Clips-Net	210		
Hercules-Ladder with acacia wood	129		
Hercules-Ladder with aluminium rung	129		
Hercules-Ladder with plastic rung.....	129		
Hexagon Tower	72		
Hourglass.....	83		
Hydra Swinger, 4-seater, double.....	105		
J			
Jungle Bridge	131		
Jungle Rope Swing.....	151		
"Junior" Play Ship	16		
L			
Lantern Climbing Nest	40		
Lantern Swing Nest.....	40		
Large Climbing Pyramid.....	78		
Lawn Protection "Hang-Roll" for hills	217		
Lawn Protection Mats.....	217		
Lawn Protection Screen Mats.....	217		
Liana Swing	41		
Little Eagle's Nest	32		
Little Eagle's Nest Carousel.....	31		
Little Eagle's Nest with slide	32		
M			
Maxi Hexagonal Climbing Castle	24		
Meeting-Point.....	42		
Middle Bollard with 1 drill hole	219		
Midi Climbing Teepee	77		
Midi-Climbing Whirl.....	43		
Mini Bird's Nest Carousel.....	46		
Mini Bird's Nest Tree	17		
Mini Climbing Pyramid.....	43		



Mini Pirate Tower	51	Robinia wood posts for Hammocks	152	Bird's Nest Swing	205
Mini Rope-End Swinger.....	27	Roman ring	128	Suspension Ropes for Bird's Nest Swing ...	205
Mini-M Slide	36	Rope Loop.....	124	Swing Bearing	202
Mini-M-Swing	148	Rope Net Pyramid DINO 1.....	174	Swing Bearing with swivel rotating effect	203
Mushroom Carousel	50	Rope Net Pyramid DINO 2.....	175	Swing Bearing, reinforced version	202
N		Rope Net Pyramid DINO 3.....	176	Swing Bed.....	151
Nest Carousel.....	47	Rope Net Pyramid DINO Mini	177	Swing Frame "Junior"	140
Net Bridge in V-Form	130	Rope Net Pyramid DINO XXL	173	Swing Frame "Twin", douglas fir.....	136
Net Bridge with wooden rungs	130	Rope Net Tower 1	171	Swing Frame, douglas fir	138
Net Handrails (both sides)	130	Rope Net Tower 2	172	Swing Seat Maxi	150
Net Seesaw with steel	49	Rope Ring Swing Carousel	150	Swing Seat Midi.....	150
Net Seesaw with wood	48	Rope-end Swing	151	Swing Seat Mini.....	150
Net Tunnel	132	Rubber Edging Cord	216	Swing Seat plastic (for private use)	149
O		Rubber Jumper	71	Swing Seat with chain	149
Olive Tree	79	Rubber Walkway	131	Swinging Honeycomb Nest.....	29
Original HUCK Bird's Nest	147	Rustic Board Swing (for private use)	149	T	
Original HUCK Bird's Nest on springs	30	S		Tarantula.....	33
Original HUCK Honeycomb Nest.....	147	Safety Bearing	201	Tension Belt.....	215
Original HUCK Mini Bird's Nest.....	147	Safty Swing Seat with chain	149	Tent Net.....	65
Original HUCK Mini Bird's Nest		Sandpit Cover	216	The Look Out	45
for Mini-M-Swing.....	147	Serpent - The Snake	85	Thimble chain sprocket stainless steel	126
Oval Rope Swing	150	Shackel rotating swivel M8.....	203	Thimble stainless steel	124
P		Shackle stainless steel M8 (cambered)	124	Thimble swivel stainless steel	126
Partner Swing "Rustikal"	151	Simple Net Bridge	130	Tightrope	56
PE Buttons	216	Simple Tyre Swing	149	Tipi.....	86
Pendulum Seat with chain	149	Slackbar	57	Toddler Swing Seat	149
Pirate Tower, steel crossbeams.....	81	Slackmaster.....	59	Toddler Swing Seat for Mini-M-Swing	148
Pirate Tower, wood crossbeams	81	Slackmaster Combination 1	60	Tower Bridge.....	64
Plastic adapter with bolt M10/M12	124	Slackmaster Combination 2	61	Tower Carousel, spinning.....	87
Plastic Link Hammock.....	152	Sleeve nut M12 stainless steel	125	Trio Swing	151
Plastic round thimble	124	Slip-on Sleeve (stainless steel)	215	Triops®-Pyramide Mini.....	162
Plates for chain coupling incl. screws.....	204	Slowworm Midi.....	55	Triple Course with slide	22
Platform	115	Space Capsule.....	82	U	
Play Cube with slide	39	Sparrow's Nest with slide	15	Universal Joint	201
"Plus" for attachment both ends	131	SPIDER 4 Pyramid with 4 guy lines	163	V	
"Plus" for bottom attachment	129	SPIDER 6 Pyramid with 4 guy lines	164	Vario-Element 1-9	112
Polyester gym ring	128	SPIDER 6 Pyramid with 6 guy lines	165	Vario-Element 10-20	113
Polyester Hammock	154	SPIDER 8 Pyramid with 6 guy lines	166	Victory Swinger.....	102
PP-Climbing Nets, Ø 16 mm.....	121	Spider Web,	53	Viking Swinger.....	100
PP-Climbing Nets, Ø 20 mm.....	121	Spinning Mushroom.....	69	Volleyball Net "Hercules-Clips-Net"	212
PP-Climbing Nets, Ø 25 mm.....	121	Spiral Carousel.....	47	Volleyball Net in "Dralo"	212
PP-Climbing rope with knots.....	127	Spring-mounted Balancing Lines.....	58	W	
PP-Climbing rope	127	Steel posts for Hammocks.....	152	Witch's Coven Version 1	63
PP-Ladder with acacia wood	129	Steel posts for Polyester Hammock.....	154	Witch's Coven Version 1	63
PP-Rope with steel core	219	Steel posts for XXL Resting Hammock	158	Witch's Slide & Net	19
PP-Walkway rope.....	131	Steel ring, galvanized.....	124	"Wobble Disc" Adventure Bridge	12
R		Sun Pavilion Cover Combination.....	215	"Wobble Rung" Adventure Bridge.....	26
Repair Kit for Bird's Nest.....	205	Super-Climb Maxi	178	"Wooden Catwalk" Adventure Bridge	25
Ring nut stainless steel	124	Super-Climb Midi	179	Wooden Walkway.....	131
		Super-Climb Mini	179		
		Supplement for bottom attachment.....	127		
		Suspension Chain Set for			



The HUCK group



Rope Play equipment
Where's a rope there's fun to be had! Our HUCK rope play equipment is made for outdoor play: Whether as a course or individual elements, we offer various colours, designs and shapes for every taste.

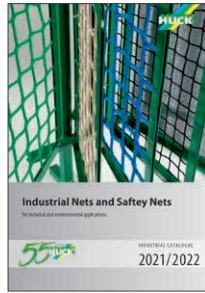

Industrial nets
Nets for technology and the environment: Whether for lifting, lashing, loading, covering, protecting or securing – whatever you have in mind, we have the right net for you.



Safety nets
Looking for fall arrest nets, scaffolding safety nets or side protection nets? We produce EN-certified safety nets which fulfil the corresponding building regulations and also hire our scaffolding safety nets out as required. Please get in touch.

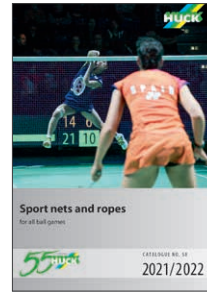

Sport nets and ropes
We produce goal and ball stop nets suitable for the respective sporting challenges. Whether for fun games or ball sports: You have come to the right place.

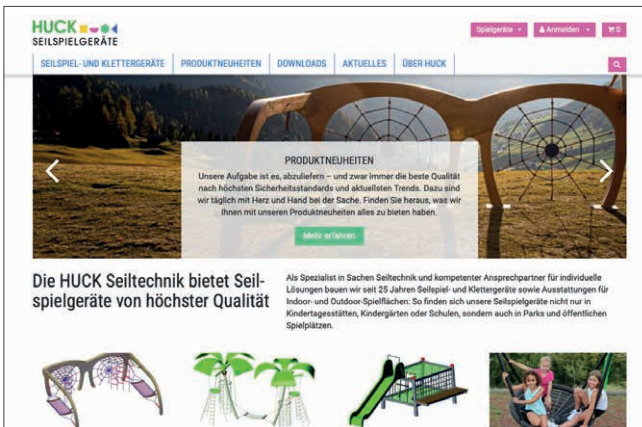



www.huck-spielgeraete.de
PLANNING, ORDERING, RESEARCHING

We showcase all our products on our website with brief descriptions, photographs and diagrams. You will also find assembly instructions and TÜV certificates. So, you can take measurements in peace and quiet and plan your projects. Browse through our current catalogues and keep up to date with our news. You'll strike gold here!

Facebook & Instagram

FOLLOW, GET INFORMATION, LIKE

Follow us on the social platforms, read and like our articles and experience it closely with us e.g. the current installation of new equipment or our trade fair attendance.

 [huck.seiltechnik](https://www.facebook.com/huck.seiltechnik)
 [huck.seiltechnik](https://www.instagram.com/huck.seiltechnik)



MEMBER OF BSFH
Federal association with play area equipment and leisure facilities.

MEMBER OF IPEMA



HUCK International

Belgium

HUCK N.V.
Atlasstraat 2
B-8680 Koekelare
☎ +32 51 58 23 20
☎ +32 51 58 20 55
✉ info.sales@huck.be
www.huck.be

Netherlands

HUCK Torimex BV
Kalkbranderstraat 5
2222BH Katwijk aan Zee
☎ +31 71 409 77-00
☎ +31 71 409 77-01
✉ sales@huck-torimex.com
www.huck.nl

Germany

HUCK Seiltechnik GmbH
Dillerberg 3
D-35614 Aßlar-Berghausen
☎ +49 6443 8311-0
☎ +49 6443 8311-79
✉ seiltechnik@huck.net
www.huck-seiltechnik.de

Sweden

ScanCord AB
Svetsaregatan 11
242 35 Hörby
☎ +46 415 15 400
☎ +46 415 15 425
✉ info@scancord.net
www.huck-scancord.net

USA

NetPlay USA LLC
226 Upton Road
Colchester, CT 06415
☎ +1 860 531 2391
☎ +1 860 537 7393
✉ sales@netplayusa.com
www.netplayusa.com

United Kingdom

HUCK Nets Ltd.
Gore Cross Business Park,
Corbin Way, Bradpole Bridport
DT6 3 UX, Dorset
☎ +44 1308 425 100
☎ +44 1308 458 109
✉ sales@hucknetting.co.uk
www.huck-net.co.uk

Spain

HUCK SPAIN
Calle Alfonso Solans Serrano 18, Local 8.
50014 Zaragoza
Spain
☎ +34 976 310 826
✉ info@huck-spain.net
www.huck-spain.net

France

HUCK Occitania S.A.
Les Clauzolles
F-81470 Maurens Scopont
☎ +33 563 82 51-31
☎ +33 563 82 51-36
✉ contact@huck-occitania.fr
www.huck-occitania.fr

Czech Republic

Berger-HUCK s.r.o.
Vanišova 552
533 74 Horní Jelení
☎ +420 466 673-306
☎ +420 466 673-305
✉ info@berger-huck.cz
www.berger-huck.cz

Austria

Berger GmbH
Industriestrasse 9
A-2000 Stockerau
☎ +43 22 66 62 126
☎ +43 22 66 62 126-27
✉ sales.at@huck.at
www.huck.at

Poland

HUCK Polska Sp. z o.o.
ul. Macieja Przybyły 1
54-512 Wrocław
☎ +48 71 325 75 40
✉ biuro@huck.pl
www.huck.pl

Turkey

Turkuaz Park Ahşap Yapı
Peyzaj İnşaat San. Tic. Ltd. Şti.
Hüseyinli Mah. Beykoz Cad.
No:145 | 34799 Ömerli-
Çekmeköy/ İSTANBUL
☎ +90 216 485 13 23
✉ info@turkuazpark.net

New Zealand

Playground Centre New Zealand
PO Box 14
Wanganui 4540
☎ +64 6 348 9054
☎ +64 6 348 9355
✉ sales@playgroundcentre.co.nz
www.playgroundcentre.com



LOVE IT!



Novelty!

Our playground equipment can be ordered in different colour variations of the ropes or plastic connectors at no extra charge.

HERCULES ROPE

Quality in a choice of colours suitable for children



Black 06

Fluorescent Orange 03F*

Hemp 08

Light Grey 66

Red 07

Pink 71

Blue 04

Yellow 05

Green 01

Turquoise 11

Rust 03

*Suitable for Indoor Use

OUR PLASTIC CONNECTORS

Colourful for more fun



Examples
HDPE Knotballs in
Blue, Yellow, Red,
Hemp and Black.

INFO

The respective 3D sketches give the rope colours and fixtures and fittings for the equipment.

The photos may show special versions in design and colour.



General terms and conditions of business

Sale and delivery terms and conditions

- Valid as of 01.05.2010

The following conditions form a significant part of the sales contract. They shall be deemed to be accepted by the buyer when an order is placed. Deviating conditions of the customer are then non-binding for us too, even if we do not expressly object to them.

Offers

All offers made on the basis of this list are without engagement, non-binding and shall not obligate us to accept an order. Offers made by telephone need to be confirmed in writing. In case of doubt, the written confirmation shall be valid.

We reserve the right to make technical alterations that serve the further development of our products and that are acceptable to the buyer.

Order units

We have the right to change differing order quantities to the next higher packing unit without enquiring. The exchange or return of custom-made products shall be precluded insofar as these are not defective.

Pricing, packaging

All prices are net and exclusive of the current statutory VAT. With the publication of this catalogue, all previous price lists shall be null and void! Upon publication of this catalogue, all previous price lists shall be null and void.

Our prices are non-binding to the extent that significant changes in raw-material prices and wages may occur after the publication of this catalogue and therefore the calculation bases may no longer apply. Should there be more than four months between the conclusion of the contract and the agreed delivery date, and unless otherwise agreed at the conclusion of the contract, our prices at the time of delivery or preparation shall apply.

We reserve the right to pass on the additional costs of raw materials in case of price increases in that area (steel, plastic, etc.) after completion of our catalogue. As a result, article prices may in some cases change correspondingly. Prices shall be valid for at least 1 year after the release of a catalogue, or until a new price list is published.

Our prices are quoted "ex works", including packaging. International payment transactions through irrevocable letter of credit.

Payment terms

10 days after invoice date 3% discount, 30 days after invoice date net. In case of late payment interest charged at 1% from the 31st day after date of invoice. Deliveries to companies not known to us are made cash on delivery or against prepayment. If court action and out-of-court collection costs becomes necessary due to payment arrears we are entitled to charge the debtor. Minimum orders below 25.00 excluding VAT calls for an administration surcharge of 4.00 net. Deliveries with an invoice amount below 50.00 are entitled to a discount.

Liabilities/complaints

Our liability shall extend to sound handmade production, use of adequate materials and stable and durable construction. You shall notify us immediately of any deficiencies discovered, at the latest within three days of receipt of the goods or of discovery of the deficiency, should this only appear later, inasmuch as the buyer is a trader. Otherwise the goods shall be presumed to be approved.

To the extent that no consumer sale has been made, we shall repair or replace free of cost at your option. Should a consumer sale have taken place, the buyer shall be able, in case of a justified complaint, to demand a repair or replacement at his option. Entitlement to a cancellation or reduction and/or to compensation shall only be given if according to our decision repairs cannot be carried out, are not possible or are unreasonable or a replacement cannot be made or the deadline for the same is not observed or an adequate extension given to us is not observed through our own fault.

Should the repair or replacement finally fail, the buyer shall be able to demand a reduction in the fee or at his option the cancellation of the contract and/ or compensation.

Warranty

The statutory provisions apply.

Guarantee

For Douglas fir posts where post shoes are used, we shall assume a guarantee of 10 years. For hot-dip galvanised steel posts, a guarantee of 15 years against rust penetration. Three years' guarantee for wooden posts in case of direct installation! For all other pieces (with the exception of wear and tear parts), we shall give a guarantee of 5 years against breakage and material defects. Our guarantee shall be assumed to the extent described under the liability clause. The

guarantee shall not extend to parts that are subject to rapid wear (wear and tear parts).

The buyer's statutory warranty rights are not affected by this. Damage attributable to wilful destruction (vandalism), incorrect installation, inadequate maintenance or natural wear and tear shall be exempt from the guarantee.

Our installation and maintenance instructions must be followed.

Delivery schedule

Delivery times specified by the buyer and their receipt do not constitute a promise of delivery. No compensation claim can be derived from a breach of delivery times. Force majeure and strikes either on our premises or on those of our preliminary suppliers shall release us from delivery obligations. If delivery is not possible, in the presence of the conditions described above, the term of delivery shall be extended.

Retention of title

Para 449 BGB (German Civil Code) forms the basis of all sales. All goods delivered by us remain in our ownership until payment in full of the current account receivables has been made. If the goods are sold on then the due purchase price is deemed to be assigned to us instead. Garnishment and any other adverse effect on our right of ownership must be reported.

Place of fulfilment

Place of fulfilment for deliveries and payment is Aßlar-Berghausen. The district court of Wetzlar/Regional court of Limburg are deemed to be agreed as place of jurisdiction, for both parts for the placement and acceptance of orders, provided that the buyer is a registered tradesman, a tradesman by law, a legal person under public law or a legal entity under public law. German law shall apply to the exclusion of the Convention on the Sale of International Goods.

Other agreements

Should individual provisions of the sales and delivery provisions be or become invalid in whole or in part, then the validity of the remaining provisions shall not be affected as a result.

Deliveries are respectively made "ex works". The loading and the necessary resources and staff must be organised by the customer. Upon request we are able to offer unloading separately for a surcharge.



ADVENTURE MADE IN GERMANY

HUCK Nets UK Ltd

Gore Cross Business Park
Corbin Way
Bridport
Dorset
DT6 3UX

Phone +44 1308 425100
www.huck-net.co.uk

Sales Director:
Jon Legg-Bagg
jon@hucknetting.co.uk

Contacts:
Tony Lucas
Phone +44 1308 425100
tony.lucas@hucktek.co.uk

Sarah Reynolds
Phone +44 1308 425100
sarah.reynolds@hucknetting.co.uk