









Bird's Nest Tree, with bridge and spiral slide

Art. No. 4652-3 Wood crossbeams

Art. No. 4652-3S Steel crossbeams



For symbol explanation see folding card at the back

-  5.95 m
-  12.65 x 7.30 m
-  114.30 m²
-  16.50 x 11.00 m
-  2.80 m
-  4.75 m³
-  42
- 

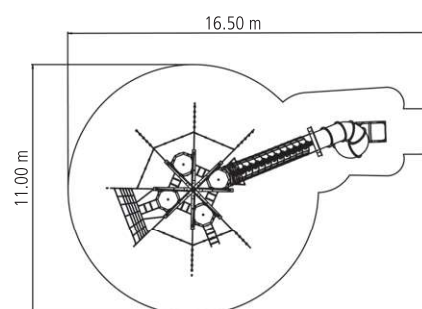
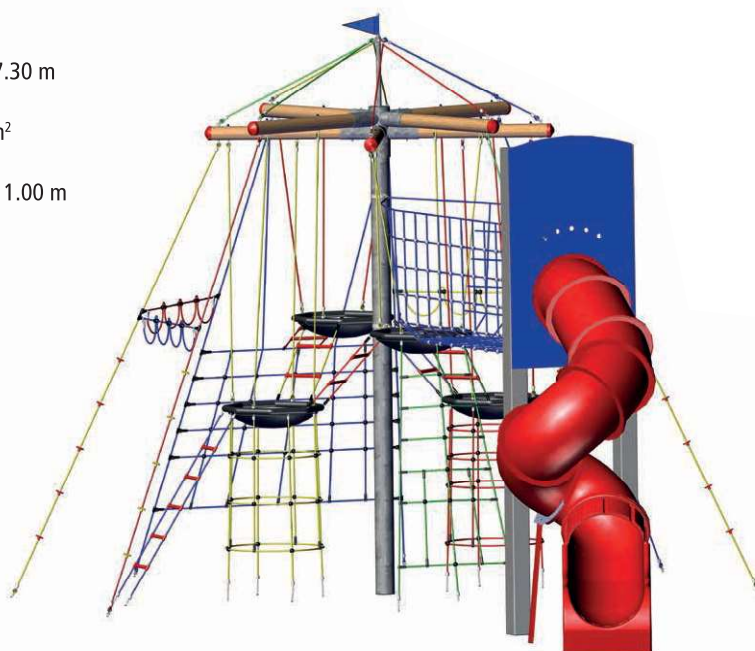

Hot-dipped galvanised steel cross beams are available upon request. Upon request also available with straight slide.